

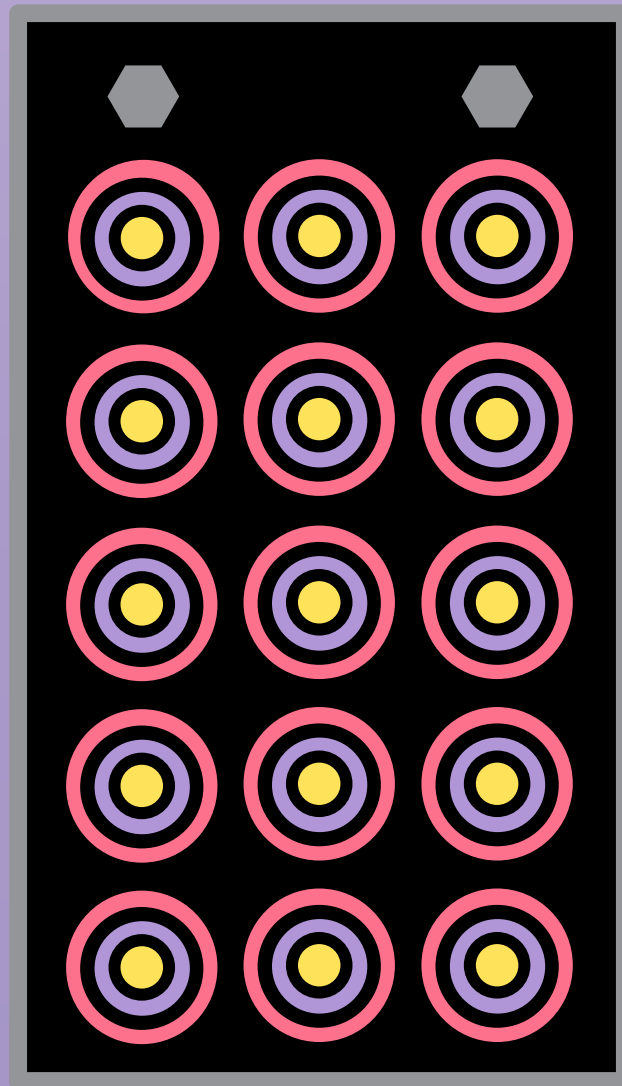

WALLMAX®



Product Catalogue

WallMax® Group



WallMax® is a company founded by professionals with extensive experience in internationally recognized companies in the industrial manufacturing sector.

The diverse skills and competences within the management team, combined with in-depth knowledge of products and worldwide geographical positioning, allow the company to capitalize on technological know-how and to optimize the functioning of operations through the strategic allocation of resources.

With a transnational approach to management, the company aims to benefit from the advantages of each location, in terms of R&D know-how, cost of labor and availability of resources.

WallMax®'s vision is to deliver to its clients the best wall feed through solutions at the most competitive price. While the company has been founded at the end of 2011, the managerial team of professionals has several decades of combined experience in the field.

Il gruppo WallMax® è stato fondato da professionisti con pluriennale esperienza in aziende operanti nel settore industriale a livello internazionale.

Una profonda conoscenza del prodotto combinata con un posizionamento geografico globale, permettono all'azienda di sfruttare i vantaggi competitivi di ogni location, sia in termini di ricerca e sviluppo che di costo del lavoro e disponibilità delle risorse.

WallMax® si impegna a fornire ai propri clienti le migliori soluzioni di sigillatura di cavi e tubi al prezzo più competitivo.

Pur essendo una realtà relativamente giovane, WallMax® beneficia della guida di un team di professionisti con decennale esperienza nel settore.

I nostri prodotti sono stati sottoposti a rigorosi test e certificati in laboratori riconosciuti a livello internazionale.

Ingress Protection Solutions

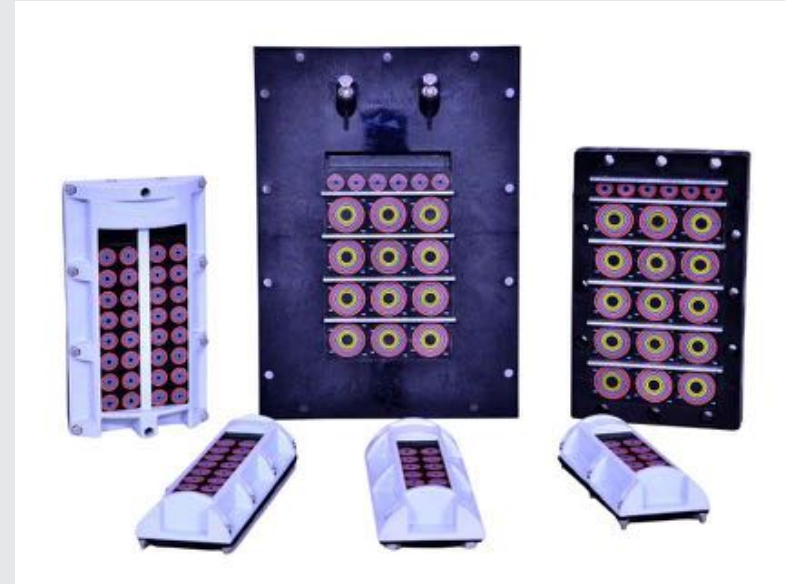

WallMax® Ingress Protection Solutions are a system of modules and frames used to perfectly seal point of entries of cables and pipes through passages in walls or shelters' partitions, so as to prevent the infiltration of dust, water, flames and other environmental elements.

The modular system is designed to accommodate the passage of cables and pipes of a large spectrum of diameters. Modules of different sizes, with openings of different diameter, can be matched together to create a customized sealing solution to protect valuable equipment.

A flexible system, that can easily be mounted and adapted to specific needs, WallMax® Ingress Protection Solutions are developed to allow for possible future modifications and reconfigurations.

I sistemi di sigillatura WallMax® sono costituiti da combinazioni di moduli e cornici e sono utilizzabili per proteggere il passaggio di cavi e tubi attraverso muri e partizioni, permettendo l'isolamento degli ambienti da acqua, polvere e fiamme.

I moduli WallMax® supportano cavi e tubi di molteplici dimensioni e possono essere combinati tra loro per formare soluzioni di sigillatura personalizzate.

Il sistema WallMax® è flessibile e facilmente adattabile alle più diverse necessità e si presta a future variazioni e modifiche di configurazione.

Index

Modules Regular Series		
WMR	WallMax® Module Regular	8
WMRwop	WallMax® Module Regular without plug	12
WP	WallMax® Plug	13
WMS	WallMax® Module Solid	14

Modules Rounded Series		
WMSR	WallMax® Module Solid Rounded	16

Modules Compact Series		
WMC	WallMax® Module Compact	18
WMSC	WallMax® Module Solid Compact	21

Metal Frames		
WRF	WallMax® Rectangular Frame	22
WRF2	WallMax® Rectangular Frame 2	30
WRFD	WallMax® Rectangular Frame Depth	36
WRFO	WallMax® Rectangular Frame Openable	42
WRFR	WallMax® Rectangular Frame Rounded	46

Flanged Metal Frames		
WRFF	WallMax® Rectangular Flanged Frame	64
WRFFO	WallMax® Rectangular Flanged Frame Openable	70
WRFFL	WallMax® Rectangular Flanged Frame Light	74
WRFFLO	WallMax® Rectangular Flanged Frame Light Openable	80
WRHFF	WallMax® Rectangular Holed Flanged Frame	84
WRHFFO	WallMax® Rectangular Holed Flanged Frame Openable	88
WRHFFL	WallMax® Rectangular Holed Flanged Frame Light	92
WRHFFLO	WallMax® Rectangular Holed Flanged Frame Light Openable	96

Modular Frame		
WMF	WallMax® Modular Frame	100

Index

Mini Frame		
WM mini	WallMax® mini Frame Top	104
WM mini	WallMax® mini Frame Back	109

Plastic Frames		
WCC PA	WallMax® Combined Compact	112
WM PA & WMF PA	WallMax® Modular Plastic Rectangular Frame & WallMax® Plastic Modular Rectangular Frame with Flange	115
WX 200 PA	WallMax® Plastic Extra Compact Frame	116
WMFC PA	WallMax® Modular Plastic Compact Frame with Flange	117

Round Frames		
WR	WallMax® Round Frame	118
SLVWR	WallMax® Sleeves for WR	122
SLVFWR	WallMax® Flanged Sleeves for WR	124

Round Squared Frames		
WRS	WallMax® Round Frame with Squared Opening	126
SLVWRS	WallMax® Sleeves for WRS	130
SLVFWRS	WallMax® Flanged Sleeves for WRS	132

Accessories		
WE	WallMax® Expander	136
WEC	WallMax® Expander Compact	136
WRP	WallMax® Retainer Plate	137
WPCT	WallMax® Pre-Compression Tools	137
WMLub	WallMax® Lubricants	138
WSS	WallMax® Sealing Strip	138

Additional Information		
KIT/Fasteners/Sealing Appendix		140
General Product Datasheets		144

WallMax® Multicolor Series

WallMax® has recently developed an easy and intuitive method to seal cables and pipes: Wallmax® Multicolor Modules.

These EPDM rubber modules are made of two black cradles where yellow, purple and red layers help the installer to easily identify peeling diameters in order to sensibly reduce installation time during the installation phase.

All modules also show minimum and maximum diameters printed on each side.

To make the installation easier, Wallmax® also impressed on each angle of the module the cable measures that can be reached by completely removing each strip of different colour (see image on the top right).

The choice of colours is not only a mere aesthetic factor, but it represents also WallMax® ongoing challenge to provide materials with more and more excellent mechanical performances.

In particular, Carbon Black ensures an increase in Compression Set, Elastic Rebound, Breaking Load, Elastic Module and the retention/preservation of mechanical features over time, thus assuring better aging resistance.

WallMax® ha elaborato un metodo facile ed intuitivo per la sigillatura di cavi o tubi: i Moduli Multicolor Wallmax®.

Questi moduli in gomma EPDM sono composti da due culle nere in cui layers di colore giallo, viola e rosso aiutano l'installatore ad identificare facilmente i diametri di peeling, ottimizzando di conseguenza i tempi di installazione.

Su ciascun lato dei moduli è stampato il range di diametri che ciascun modulo può allocare.

Inoltre, al fine di facilitare ulteriormente l'installazione, in corrispondenza degli angoli esterni è stata impressa la dimensione di cavo che si raggiunge rimuovendo completamente ogni fascia di diverso colore (vedi immagine in alto a destra).

La scelta dei colori, quindi, non è stata dettata da un fattore puramente estetico, ma rappresenta la sfida costante di WallMax® nel fornire materiali che garantiscano performance meccaniche ottimali.

In particolare, l'utilizzo del Carbon Black favorisce il potenziamento di Compression Set, Rebound Elastico, Carico di Rottura, Modulo Elastico e consente la conservazione delle proprie caratteristiche meccaniche nel tempo grazie ad una migliore resistenza all'invecchiamento.

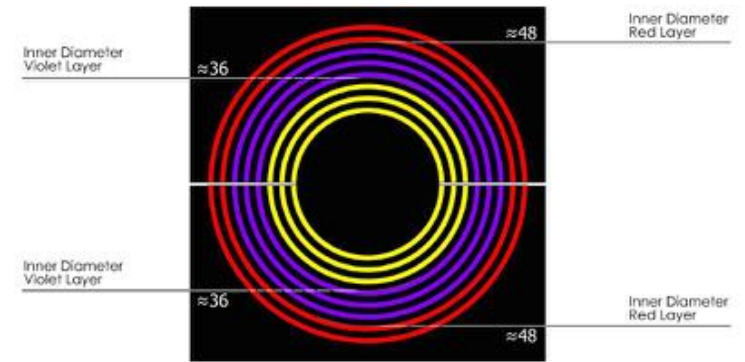

WMR Series

WallMax® Module Regular

WallMax® Module Regular

WallMax® Regular Modules are made of two rubber cradles with a central opening to accommodate the passage of cables and pipes.

Modules are designed to fit a large variety of cable sizes, as the inner structure of each half consists of separate layers, which can be easily peeled off to allow for maximum range of adaptability.

With a solid core, WallMax® Modules can be used to fill up frame space where cable passage is not needed, while at the same time constituting a spare part for future use. Standard depth of each Regular Module is 60mm.

Moduli Standard WallMax®

I Moduli Standard WallMax® sono formati da due culle di gomma con un foro centrale per consentire il passaggio di cavi e tubi.

I moduli sono progettati per adattarsi a cavi con diametri di diverse dimensioni, grazie alla struttura interna formata da strati di gomma facilmente rimovibili che garantiscono la massima flessibilità di installazione.

Grazie alla presenza di un cilindretto centrale che sigilla il punto d'ingresso i Moduli Standard possono essere usati anche per riempire spazi non impiegati per il passaggio di cavi, permettendo future modifiche e successivo utilizzo in caso di necessità.

La profondità di ogni Modulo Standard è di 60mm.





WallMax® Module Regular

WallMax® Modules allow for quick, easy installation. Combining modules with single and multiple openings maximizes the utilization of packing space within a frame.

MATERIAL	MATERIALE
EPDM Rubber	Gomma EPDM

Moduli Standard WallMax®

I moduli WallMax® consentono un'installazione semplice e veloce. Combinare moduli con foro singolo a modelli con aperture multiple permette di massimizzare l'utilizzo dello spazio di riempimento all'interno di una cornice.

WMR series								
PICTURE DISEGNO	CODE CODICE	ARTICLE ARTICOLO	ACCOMODATES CABLE/PIPE DIAMETER		EXTERNAL DIMENSIONS (mm)	WEIGHT		
			PER CAVI O TUBI DI DIAMETRO	ø mm	ø in	DIMENSIONI ESTERNE (mm) HxW(D=60mm)	PESO	
							g	lb
	71 6000 0015	WMR 15	0+ 2.5-11.6	0+ 0.098-0.457	15x15	16	0.035	
	71 6000 4015	WMR 15w40	0+ 2.5-11.6	0+ 0.098-0.457	15x40	42	0.093	
	71 6000 0020	WMR 20	0+ 4.0-16.5	0+ 0.157-0.650	20x20	28	0.062	
	71 6000 4020	WMR 20w40	0+ 4.0-16.5	0+ 0.157-0.650	20x40	54	0.119	
	71 6000 0030	WMR 30	0+ 10.0-25.0	0+ 0.394-0.984	30x30	63	0.139	
	71 6000 4030	WMR 30w40	0+ 10.0-25.0	0+ 0.394-0.984	30x40	84	0.185	
	71 6000 0040	WMR 40	0+ 21.5-34.5	0+ 0.846-1.358	40x40	113	0.256	
	71 6000 1040	WMR 40 10-34	0+ 10.0-34.5	0+ 0.394-1.358	40x40	112	0.247	
	71 6000 0060	WMR 60	0+ 24.0-54.0	0+ 0.945-2.126	60x60	254	0.560	

WMR series								
PICTURE DISEGNO	CODE CODICE	ARTICLE ARTICOLO	ACCOMODATES CABLE/PIPE DIAMETER		EXTERNAL DIMENSIONS (mm)	WEIGHT		
			PER CAVI O TUBI DI DIAMETRO	ø mm	ø in	DIMENSIONI ESTERNE (mm) HxW(D=60mm)	PESO	
							g	lb
	71 6000 2860	WMR 60 28-54	0+ 28.0-54.0	0+ 1.102-2.126	60x60	254	0.560	
	71 6000 0080	WMR 80	0+ 48.0-71.0	0+ 1.890-2.795	80x80	452	0.996	
	71 6000 0090	WMR 90	0+ 48.0-71.0	0+ 1.890-2.795	90x90	572	1.261	
	71 6000 0120	WMR 120	0+ 67.5-99.0	0+ 2.657-3.898	120x120	1028	2.266	

DATASHEET PAGE: 144

NOTE: Weights are approximate.
NOTA: I pesi dichiarati sono indicativi.

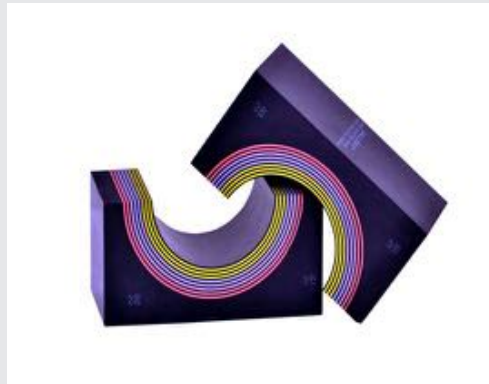

WallMax® Regular Module without plug

WallMax® Regular Modules Without Plug are designed to accommodate pipes or cables of large diameter. They are an alternative to Regular Modules allowing clients to save on the cost of large rubber cores. Modules Without Plug can be matched with WallMax® Plugs to seal wall entries, when need calls to adapt passages that used to accommodate a pipe or cable.

Modulo Standard WallMax® senza cilindretto

I Moduli Standard Senza Cilindretto centrale sono pensati per sigillare il passaggio di cavi e tubi di grandi dimensioni. I WMR WOP sono alternative più economiche rispetto ai classici Moduli Standard, perchè permettono di risparmiare il costo del cuore di gomma. Possono essere abbinati ai cilindretti WP per sigillare i punti di ingresso in caso di successive modifiche alle configurazioni di installazione.

MATERIAL	MATERIALE
EPDM Rubber	Gomma EPDM

WMR series								
PICTURE DISEGNO	CODE CODICE	ARTICLE ARTICOLO	ACCOMODATES CABLE/PIPE DIAMETER		EXTERNAL DIMENSIONS (mm)		WEIGHT	
			PER CAVI O TUBI DI DIAMETRO		DIMENSIONI ESTERNE (mm)		PESO	
			ø mm	ø in	HxW(D=60mm)		g	lb
	71 6001 0060	WMR 60wop	24.0-54.0	0.945-2.126	60x60		222	0.489
	71 6001 2860	WMR 60wop 28-54	28.0-54.0	1.102-2.126	60x60		210	0.463
	71 6001 0080	WMR 80wop	48.0-71.0	1.890-2.795	80x80		324	0.714
	71 6001 0090	WMR 90wop	48.0-71.0	1.890-2.795	90x90		444	0.979
	71 6001 0120	WMR 120wop	67.5-99.0	2.657-3.898	120x120		770	1.698

NOTE: Weights are approximate.
NOTA: I pesi dichiarati sono indicativi.



WallMax® Plug

WallMax® Plugs are useful complements to WallMax® Regular Modules Without Plugs. The cylinders can be used as plugs to seal existing wall installations without the need to completely replace the old modules in case of cable or pipe removal.

Cilindretto WallMax®

I Cilindretti WallMax® sono pensati per completare i Moduli Standard WOP. I cilindretti possono essere utilizzati come tappi per sigillare installazioni a muro già esistenti, senza la necessità di sostituire interamente i vecchi moduli nel caso di rimozione del cavo o tubo.

MATERIAL	MATERIALE
EPDM Rubber	Gomma EPDM

To be used in combination with/utilizzate in combinazione con

WMR series						
CODE CODICE	ARTICLE ARTICOLO	EXTERNAL DIMENSIONS (mm)		Depth (mm) Profondità (mm)	WEIGHT	
		DIMENSIONI ESTERNE (mm)			PESO	
		ø mm	ø in	g	lb	
71 6002 0021	WP 21	21.5	0.846	60	26	0.057
71 6002 0024	WP 24	24	0.945	60	32	0.070
71 6002 0028	WP 28	28	1.102	60	50	0.110
71 6002 0048	WP 48	48	1.889	60	160	0.353
71 6002 0068	WP 68	68	2.677	60	320	0.705
71 6002 0093	WP 93	93	3.661	60	481	1.059

Customized sizes of plugs can be provided in different lengths for special requests
Cilindretti di lunghezze personalizzate possono essere realizzati su richiesta

NOTE: Weights are approximate.
NOTA: I pesi dichiarati sono indicativi.



WallMax® Module Solid

WallMax® Solid Modules are solid rubber blocks, which provide a useful alternative to Standard modules with openings for completing sealing solutions.

They can be utilized to fill up the space inside Frames, where a passage of cable is not needed, in combination with Regular Modules.

Modulo Solido WallMax®

I Moduli Solidi WallMax® sono blocchi di gomma, utilizzabili insieme ai Moduli Standard per creare soluzioni di sigillatura personalizzate. Possono essere impiegati per riempire gli spazi in cui non sia previsto il passaggio di cavi o tubi consentendo al contempo un risparmio sui costi rispetto l'utilizzo di Moduli Standard.

MATERIAL	MATERIALE
EPDM Rubber	Gomma EPDM

WMR series		EXTERNAL DIMENSIONS (mm)	WEIGHT	
CODE	ARTICLE	DIMENSIONI ESTERNE (mm)	PESO	
CODICE	ARTICOLO	HxW (D=60mm)	g	lb
71 6003 0504	WMS 5x40	5x40	14	0.030
71 6003 1004	WMS 10x40	10x40	28	0.061
71 6003 0506	WMS 5x60	5x60	21	0.046
71 6003 1006	WMS 10x60	10x60	43	0.094
71 6003 0512	WMS 5x120	5x120	43	0.094
71 6003 1012	WMS 10x120	10x120	85	0.187
71 6003 0015	WMS 15	15x15	16	0.035

WMR series		EXTERNAL DIMENSIONS (mm)	WEIGHT	
CODE	ARTICLE	DIMENSIONI ESTERNE (mm)	PESO	
CODICE	ARTICOLO	HxW (D=60mm)	g	lb
71 6003 0020	WMS 20	20x20	28	0.062
71 6003 0030	WMS 30	30x30	64	0.141
71 6003 0040	WMS 40	40x40	113	0.249
71 6003 0060	WMS 60	60x60	255	0.562

DATASHEET PAGE: 145

NOTE: Weights are approximate.
NOTA: I pesi dichiarati sono indicativi.

WMSR Series

WallMax® Module Solid Rounded



WallMax® Module Solid Rounded

WallMax® Modules Solid Rounded are designed to finish the sealing in the rounded edges of rounded rectangular frames (WRFR Series, see pg. 46). WallMax® Modules Solid Rounded have a depth of 60mm. WMSR modules must be used in combination with WRFR.

Modulo Solido Arrotondato WallMax®

I Moduli Solidi Arrotondati WallMax® sono pensati per terminare la sigillatura nei bordi delle cornici con angoli arrotondati (WRFR Series, guardare pg. 46). I Moduli Solidi Arrotondati WallMax® hanno una profondità di 60 mm. La gamma di moduli WMSR è pensata per l'utilizzo con cornici WRFR.

MATERIAL	MATERIALE
EPDM Rubber	Gomma EPDM

WMSR series					
CODE	ARTICLE	EXTERNAL DIMENSIONS (mm)		WEIGHT	
CODICE	ARTICOLO	DIMENSIONI ESTERNE (mm)		PESO	
		HxWxR (D=60mm)		g	lb
71 6003 2020	WMSR 20 R2	20x20x20		22	0.049
71 6003 2040	WMSR 40 R4	40x40x40		61	0.134
71 6003 2060	WMSR 60 R6	60x60x60		87	0.192

NOTE: Weights are approximate.
NOTA: I pesi dichiarati sono indicativi.



WMC Series

WallMax® Module Compact

WallMax® Module Compact

WallMax® Modules Compact offer the same technology and adaptability of WallMax Modules Regular but are designed for use where need calls for thinner frames. Cut at half the length of WallMax® Regular Modules, at 30mm instead of 60mm, they are significantly lighter, while retaining the same ease of use of the WMR series. WMC modules are available with single and multiple openings, to offer maximum efficiency of packing space. Compact modules are used in combination with WallMax® mini R series, and with WCC PA, WX 200 PA and WMFC PA frames. The standard depth of each Compact Module is 30mm.

Modulo Compatto WallMax®

I Moduli Compatti WallMax® offrono la stessa tecnologia a strati e la stessa flessibilità di installazione dei Moduli Standard, ma sono pensati per utilizzi in soluzioni di sigillatura leggere. I Moduli Compatti hanno lunghezza di 30 mm e sono disponibili con singola apertura centrale o in combinazione doppia o tripla, per consentire il massimo utilizzo degli spazi di riempimento. La gamma di moduli WMC è pensata per l'utilizzo con cornici WM mini R, WCC PA, WX 200 PA e WMFC PA. La profondità di ogni Modulo Compatto è di 30mm.



WallMax® Module Compact

WMC Modules come in a various numbers of sizes and diameter openings, allowing clients to design the best possible sealing solution for every specific need.

Modulo Compatto WallMax®

I moduli WMC sono disponibili in diverse dimensioni e con un'ampia gamma di diametri, per permettere al cliente di progettare la soluzione di sigillatura che meglio si adatta alle sue esigenze.

MATERIAL	MATERIALE
EPDM Rubber	Gomma EPDM



WMC series							
PICTURE DISEGNO	CODE CODICE	ARTICLE ARTICOLO	ACCOMODATES CABLE/PIPE DIAMETER		EXTERNAL DIMENSIONS (mm)	WEIGHT	
			PER CAVI O TUBI DI DIAMETRO		DIMENSIONI ESTERNE (mm)	PESO	
			ø mm	ø in	HxW (D=30mm)	g	lb
	71 3000 0015	WMC 15	0 + 2.5 - 11.6	0 + 0.098 - 0.457	15x15	8	0.018
	71 3000 4015	WMC 15w40	0 + 2.5 - 11.6	0 + 0.098 - 0.457	15x40	21	0.046
	713000 0020	WMC 20	0 + 4.0 - 16.5	0 + 0.157 - 0.650	20x20	14	0.031
	71 3000 4020	WMC 20w40	0 + 4.0 - 16.5	0 + 0.157 - 0.650	20x40	26	0.057
	71 3000 0030	WMC 30	0 + 10.0 - 25.0	0 + 0.394 - 0.984	30x30	32	0.071
	71 3000 4030	WMC 30w40	0 + 10.0 - 25.0	0 + 0.394 - 0.984	30x40	42	0.093
	71 3000 0040	WMC 40	0 + 21.5 - 34.5	0 + 0.846 - 1.358	40x40	57	0.126
	71 3000 1040	WMC 40 10-34	0 + 10.0 - 34.5	0 + 0.394 - 1.358	40x40	55	0.121
	71 3000 0050	WMC 50	0 + 28.0 - 44.0	0 + 1.102 - 1.732	50x50	88	0.194
	71 3000 1050	WMC 50 10-44	0 + 10.0 - 44.0	0 + 0.394 - 1.732	50x50	88	0.194
	71 3000 0060	WMC 60	0 + 24.0 - 54.0	0 + 0.945 - 2.126	60x60	127	0.280

NOTE: Weights are approximate.
NOTA: I pesi dichiarati sono indicativi.

DATASHEET PAGE: 146

WallMax® Module Solid Compact

WallMax Modules Solid Compact are designed to complement WallMax Regular Modules Compact inside sealing solutions. With half the length of WMS, at 30mm instead of 60mm, they can be utilized to fill up space inside WallMax mini R, WCC PA, WX 200 PA, WMFC PA.

Modulo Solido Compatto WallMax®

I Moduli Solidi Compatti WallMax sono utilizzabili assieme ai Moduli Standard Compatti, in particolare in combinazione con le cornici WallMax mini R, WCC PA, WX 200 PA, WMFC PA. I blocchi WMSC hanno lunghezza di 30mm.



MATERIAL	MATERIALE
EPDM Rubber	Gomma EPDM

WMC series				
CODE CODICE	ARTICLE ARTICOLO	EXTERNAL DIMENSIONS (mm)	WEIGHT	
		DIMENSIONI ESTERNE (mm)	PESO	
		HxW (D=30mm)	g	lb
71 3003 0504	WMSC 5x40	5x40	7	0.015
71 3003 1004	WMSC 10x40	10x40	14	0.031
71 3003 0512	WMSC 5x120	5x120	21	0.046
71 3003 1012	WMSC 10x120	10x120	44	0.095

DATASHEET PAGE: 147

NOTE: Weights are approximate.
NOTA: I pesi dichiarati sono indicativi.

WRF

WallMax® Rectangular Frame

WallMax® Rectangular Frame

WallMax® Rectangular Frames are metal structures with single or multiple openings. A large variety of combinations is available in terms of openings, sizes and materials, allowing to satisfy specific customer needs. WRF solutions are designed for installation through welding.

Cornice Rettangolare WallMax®

Le Cornici Rettangolari WallMax® sono telai in metallo con aperture singola o multipla. WallMax® offre un'ampia gamma di combinazioni, con la possibilità di personalizzare le cornici sia in termini di numero di aperture che di scelta di materiali. I telai WRF sono pensati per soluzioni di installazione tramite saldatura.



WallMax® Rectangular
Frame

WRF frames are used in combination with WMR series modules and accessories to achieve customized sealing solutions. The numerous combinations of openings and packing space allow for development of cable transit solutions specific to customer needs.

Cornice Rettangolare
WallMax®

Le cornici WRF sono utilizzate in combinazione con i moduli e gli accessori della gamma WMR per offrire soluzioni di sigillatura personalizzate. Sono disponibili varie combinazioni di aperture e dimensioni con le quali si possono ottenere differenti soluzioni di passaggio cavi, a seconda delle specifiche necessità del cliente.



MATERIALS	MATERIALI
Primed Steel	Acciaio con prima mano antiruggine
SS AISI 316 L	Acciaio inox resistente agli acidi
Aluminium	Aluminio
Other materials available upon request	Disponibile in altri materiali su richiesta

DATASHEET PAGE: 148

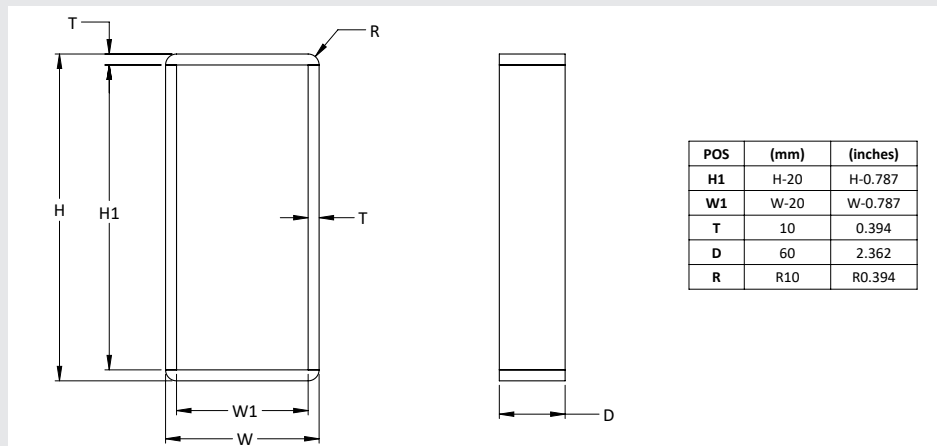

To be used in combination with/utilizzate in combinazione con

WMR series									
PICTURE DISEGNO	CODE CODICE	ARTICLE ARTICOLO	OPENINGS APERTURE TELAIO	PACKING SPACE SPAZIO DI RIEMPIMENTO mm	EXTERNAL NOMINAL DIMENSIONS DIMENSIONI ESTERNE NOMINALI HxW (D=60mm)		WEIGHT PESO		
					mm	in	kg	lb	
	71 1000 0611	WRF 60 1x1 Primed	1x1	60x120	118x140	4.646x5.512	2.19	4.828	
	71 1000 0612	WRF 60 1x2 Primed	1x2	60x120	118x270	4.646x10.630	3.96	8.730	
	71 1000 0613	WRF 60 1x3 Primed	1x3	60x120	118x400	4.646x15.748	5.73	12.624	
	71 1000 0614	WRF 60 1x4 Primed	1x4	60x120	118x530	4.646x20.866	7.49	16.521	
	71 1000 0615	WRF 60 1x5 Primed	1x5	60x120	118x660	4.646x25.984	9.26	20.419	
	71 1000 0616	WRF 60 1x6 Primed	1x6	60x120	118x790	4.646x31.102	11.03	24.317	
	71 1000 1211	WRF 120 1x1 Primed	1x1	120x120	178x140	7.008x5.512	2.75	6.061	
	71 1000 1212	WRF 120 1x2 Primed	1x2	120x120	178x270	7.008x10.630	4.80	10.580	
	71 1000 1213	WRF 120 1x3 Primed	1x3	120x120	178x400	7.008x15.748	6.85	15.099	
	71 1000 1214	WRF 120 1x4 Primed	1x4	120x120	178x530	7.008x20.866	8.90	19.621	
	71 1000 1215	WRF 120 1x5 Primed	1x5	120x120	178x660	7.008x25.984	10.95	24.141	
	71 1000 1216	WRF 120 1x6 Primed	1x6	120x120	178x790	7.008x31.102	13.00	28.660	
	71 1000 1217	WRF 120 1x7 Primed	1x7	120x120	178x920	7.008x36.221	15.05	33.180	
	71 1000 1218	WRF 120 1x8 Primed	1x8	120x120	178x1050	7.008x41.339	17.10	37.699	
	71 1000 1219	WRF 120 1x9 Primed	1x9	120x120	178x1180	7.008x46.457	19.15	42.219	
	71 1000 1221	WRF 120 2x1 Primed	2x1	120x120	346x140	13.622x5.512	4.88	10.765	
	71 1000 1222	WRF 120 2x2 Primed	2x2	120x120	356x270	14.016x10.630	9.6	21.248	
	71 1000 1223	WRF 120 2x3 Primed	2x3	120x120	356x400	14.016x15.748	13.74	30.287	
	71 1000 1224	WRF 120 2x4 Primed	2x4	120x120	356x530	14.016x20.866	18.17	40.047	
	71 1000 1225	WRF 120 2x5 Primed	2x5	120x120	356x660	14.016x25.984	22.59	49.809	
	71 1000 1226	WRF 120 2x6 Primed	2x6	120x120	356x790	14.016x31.102	27.02	59.571	
	71 1000 1227	WRF 120 2x7 Primed	2x7	120x120	356x920	14.016x36.221	31.45	69.331	
	71 1000 1228	WRF 120 2x8 Primed	2x8	120x120	356x1050	14.016x41.339	35.88	79.093	
	71 1000 1231	WRF 120 3x1 Primed	3x1	120x120	514x140	20.236x5.512	7.02	15.470	
	71 1000 1232	WRF 120 3x2 Primed	3x2	120x120	534x270	21.220x10.630	14.48	31.916	
	71 1000 1233	WRF 120 3x3 Primed	3x3	120x120	534x400	21.220x15.748	20.63	45.475	
	71 1000 1234	WRF 120 3x4 Primed	3x4	120x120	534x530	21.220x20.866	27.43	60.477	
	71 1000 1235	WRF 120 3x5 Primed	3x5	120x120	534x660	21.220x25.984	34.24	75.480	
	71 1000 1236	WRF 120 3x6 Primed	3x6	120x120	534x790	21.220x31.102	41.04	90.482	
	71 1000 1811	WRF 180 1x1 Primed	1x1	180x120	238x140	9.370x5.512	3.31	7.300	
	71 1000 1812	WRF 180 1x2 Primed	1x2	180x120	238x270	9.370x10.630	5.64	12.436	

WMR series								
PICTURE DISEGNO	CODE CODICE	ARTICLE ARTICOLO	OPENINGS APERTURE TELAIO	PACKING SPACE SPAZIO DI RIEMPIMENTO	EXTERNAL NOMINAL DIMENSIONS		WEIGHT	
					mm	in	kg	lb
	71 1000 1813	WRF 180 1x3 Primed	1x3	180x120	238x400	9.370x15.748	7.97	17.575
	71 1000 1814	WRF 180 1x4 Primed	1x4	180x120	238x530	9.370x20.866	10.30	22.714
	71 1000 1815	WRF 180 1x5 Primed	1x5	180x120	238x660	9.370x26.984	12.63	27.844
	71 1000 1816	WRF 180 1x6 Primed	1x6	180x120	238x790	9.370x31.102	14.99	33.047
	71 1000 1817	WRF 180 1x7 Primed	1x7	180x120	238x920	9.370x36.221	17.32	38.184
	71 1000 1818	WRF 180 1x8 Primed	1x8	180x120	238x1050	9.370x41.339	19.65	43.321
	71 1000 1819	WRF 180 1x9 Primed	1x9	180x120	238x1180	9.370x46.457	21.98	48.458
	71 1000 1821	WRF 180 2x1 Primed	2x1	180x120	466x140	18.347x5.512	6.01	13.241
	71 1000 1822	WRF 180 2x2 Primed	2x2	180x120	476x270	18.740x10.630	11.32	24.963
	71 1000 1823	WRF 180 2x3 Primed	2x3	180x120	476x400	18.740x15.748	15.98	35.239
	71 1000 1824	WRF 180 2x4 Primed	2x4	180x120	476x530	18.740x20.866	20.65	45.514
	71 1000 1825	WRF 180 2x5 Primed	2x5	180x120	476x660	18.740x25.984	25.31	55.792
	71 1000 1826	WRF 180 2x6 Primed	2x6	180x120	476x790	18.740x31.102	29.97	66.068
	71 1000 1827	WRF 180 2x7 Primed	2x7	180x120	476x920	18.740x36.221	35.94	79.234
	71 1000 1828	WRF 180 2x8 Primed	2x8	180x120	476x1050	18.740x41.339	40.93	90.233
	71 1000 1829	WRF 180 2x9 Primed	2x9	180x120	476x1180	18.740x46.457	45.92	101.232
	71 1000 1820	WRF 180 2x10 Primed	2x10	180x120	476x1310	18.740x51.575	50.91	112.231
	71 1000 1831	WRF 180 3x1 Primed	3x1	180x120	694x140	27.323x5.512	8.70	19.185
	71 1000 2411	WRF 240 1x1 Primed	1x1	240x120	298x140	11.732x5.512	3.87	8.536
	71 1000 2412	WRF 240 1x2 Primed	1x2	240x120	298x270	11.733x10.630	6.48	14.295
	71 1000 2413	WRF 240 1x3 Primed	1x3	240x120	298x400	11.732x15.748	9.10	20.051
	71 1000 2414	WRF 240 1x4 Primed	1x4	240x120	298x530	11.732x20.866	11.71	25.816
	71 1000 2415	WRF 240 1x5 Primed	1x5	240x120	298x660	11.732x25.984	14.32	31.570
	71 1000 2416	WRF 240 1x6 Primed	1x6	240x120	298x790	11.732x31.102	16.93	37.324
	71 1000 2421	WRF 240 2x1 Primed	2x1	240x120	586x140	23.071x5.512	7.13	15.719
	71 1000 2422	WRF 240 2x2 Primed	2x2	240x120	596x270	23.465x10.630	13.01	28.678
	71 1000 2423	WRF 240 2x3 Primed	2x3	240x120	596x400	23.465x15.748	18.23	40.192
	71 1000 2424	WRF 240 2x4 Primed	2x4	240x120	596x530	23.465x20.866	23.78	52.430
	71 1000 2425	WRF 240 2x5 Primed	2x5	240x120	596x660	23.465x25.984	29.33	64.666
	71 1000 2426	WRF 240 2x6 Primed	2x6	240x120	596x790	23.465x31.102	34.88	76.904
	71 1000 2427	WRF 240 2x7 Primed	2x7	240x120	596x920	23.465x36.221	40.43	89.140

WMR series								
PICTURE DISEGNO	CODE CODICE	ARTICLE ARTICOLO	OPENINGS APERTURE TELAIO	PACKING SPACE SPAZIO DI RIEMPIMENTO	EXTERNAL NOMINAL DIMENSIONS		WEIGHT	
					mm	in	kg	lb
	71 1000 2428	WRF 240 2x8 Primed	2x8	240x120	596x1050	23.465x41.339	45.98	101.377
	71 1000 2429	WRF 240 2x9 Primed	2x9	240x120	596x1180	23.465x46.457	51.53	113.613
	71 1000 2420	WRF 240 2x10 Primed	2x10	240x120	596x1310	23.465x51.575	57.09	125.851
	71 1000 2431	WRF 240 3x1 Primed	3x1	240x120	874x140	34.409x5.512	10.39	22.899
	71 1001 0611	WRF 60 1x1 AISI 316	1x1	60x120	118x140	4.646x5.512	2.24	4.938
	71 1001 0612	WRF 60 1x2 AISI 316	1x2	60x120	118x270	4.646x10.630	4.06	8.951
	71 1001 0613	WRF 60 1x3 AISI 316	1x3	60x120	118x400	4.646x15.748	5.87	12.946
	71 1001 0614	WRF 60 1x4 AISI 316	1x4	60x120	118x530	4.646x20.866	7.69	16.945
	71 1001 0615	WRF 60 1x5 AISI 316	1x5	60x120	118x660	4.646x25.984	9.50	20.948
	71 1001 0616	WRF 60 1x6 AISI 316	1x6	60x120	118x790	4.646x31.102	11.32	24.952
	71 1001 1211	WRF 120 1x1 AISI 316	1x1	120x120	178x140	7.008x5.512	2.82	6.217
	71 1001 1212	WRF 120 1x2 AISI 316	1x2	120x120	178x270	7.008x10.630	4.92	10.851
	71 1001 1213	WRF 120 1x3 AISI 316	1x3	120x120	178x400	7.008x15.748	7.02	15.476
	71 1001 1214	WRF 120 1x4 AISI 316	1x4	120x120	178x530	7.008x20.866	9.03	19.908
	71 1001 1215	WRF 120 1x5 AISI 316	1x5	120x120	178x660	7.008x25.984	11.04	24.339
	71 1001 1216	WRF 120 1x6 AISI 316	1x6	120x120	178x790	7.008x31.102	13.05	28.770
	71 1001 1221	WRF 120 2x1 AISI 316	2x1	120x120	346x140	13.622x5.512	5.00	11.023
	71 1001 1231	WRF 120 3x1 AISI 316	3x1	120x120	514x140	20.236x5.512	6.60	14.550
	71 1001 1811	WRF 180 1x1 AISI 316	1x1	180x120	238x140	9.370x5.512	3.40	7.487
	71 1001 1812	WRF 180 1x2 AISI 316	1x2	180x120	238x270	9.370x10.630	5.79	12.756
	71 1001 1813	WRF 180 1x3 AISI 316	1x3	180x120	238x400	9.370x15.748	8.18	18.025
	71 1001 1814	WRF 180 1x4 AISI 316	1x4	180x120	238x530	9.370x20.866	10.57	23.294
	71 1001 1815	WRF 180 1x5 AISI 316	1x5	180x120	238x660	9.370x26.984	12.96	28.563
	71 1001 1816	WRF 180 1x6 AISI 316	1x6	180x120	238x790	9.370x31.102	15.36	33.854
	71 1001 1821	WRF 180 2x1 AISI 316	2x1	180x120	466x140	18.347x5.512	6.16	13.580
	71 1001 2411	WRF 240 1x1 AISI 316	1x1	240x120	298x140	11.732x5.512	3.97	8.757
	71 1001 2412	WRF 240 1x2 AISI 316	1x2	240x120	298x270	11.733x10.630	6.65	14.661
	71 1001 2413	WRF 240 1x3 AISI 316	1x3	240x120	298x400	11.732x15.748	9.33	20.569
	71 1001 2414	WRF 240 1x4 AISI 316	1x4	240x120	298x530	11.732x20.866	12.01	26.475
	71 1001 2415	WRF 240 1x5 AISI 316	1x5	240x120	298x660	11.732x25.984	14.69	32.381
	71 1001 2416	WRF 240 1x6 AISI 316	1x6	240x120	298x790	11.732x31.102	17.37	38.287

WMR series								
PICTURE DISEGNO	CODE CODICE	ARTICLE ARTICOLO	OPENINGS APERTURE TELAIO	PACKING SPACE SPAZIO DI RIEMPIMENTO	EXTERNAL NOMINAL DIMENSIONS		WEIGHT	
					mm	in	kg	lb
	71 1001 2421	WRF 240 2x1 AISI 316	2x1	240x120	586x140	23.071x5.512	7.31	16.120
	71 1001 2431	WRF 240 3x1 AISI 316	3x1	240x120	874x140	34.409x5.512	10.65	23.486
	71 1002 0611	WRF 60 1x1 AL	1x1	60x120	118x140	4.646x5.512	0.76	1.669
	71 1002 0612	WRF 60 1x2 AL	1x2	60x120	118x270	4.646x10.630	1.37	3.020
	71 1002 0613	WRF 60 1x3 AL	1x3	60x120	118x400	4.646x15.748	1.98	4.365
	71 1002 0614	WRF 60 1x4 AL	1x4	60x120	118x530	4.646x20.866	2.59	5.719
	71 1002 0615	WRF 60 1x5 AL	1x5	60x120	118x660	4.646x25.984	3.21	7.070
	71 1002 0616	WRF 60 1x6 AL	1x6	60x120	118x790	4.646x31.102	3.82	8.424
	71 1002 0621	WRF 60 2x1 AL	2x1	60x120	226x140	9.134x5.512	1.30	2.870
	71 1002 0631	WRF 60 3x1 AL	3x1	60x120	334x140	13.504x5.512	1.85	4.070
	71 1002 1211	WRF 120 1x1 AL	1x1	120x120	178x140	7.008x5.512	0.95	2.094
	71 1002 1212	WRF 120 1x2 AL	1x2	120x120	178x270	7.008x10.630	1.66	3.662
	71 1002 1213	WRF 120 1x3 AL	1x3	120x120	178x400	7.008x15.748	2.37	5.255
	71 1002 1214	WRF 120 1x4 AL	1x4	120x120	178x530	7.008x20.866	3.08	6.790
	71 1002 1215	WRF 120 1x5 AL	1x5	120x120	178x660	7.008x25.984	3.79	8.356
	71 1002 1216	WRF 120 1x6 AL	1x6	120x120	178x790	7.008x31.102	4.50	9.921
	71 1002 1221	WRF 120 2x1 AL	2x1	120x120	346x140	13.622x5.512	1.61	3.547
	71 1002 1222	WRF 120 2x2 AL	2x2	120x120	356x270	14.016x10.630	3.34	7.355
	71 1002 1223	WRF 120 2x3 AL	2x3	120x120	356x400	14.016x15.748	4.78	10.527
	71 1002 1224	WRF 120 2x4 AL	2x4	120x120	356x530	14.016x20.866	6.36	14.017
	71 1002 1231	WRF 120 3x1 AL	3x1	120x120	514x140	20.236x5.512	2.43	5.355
	71 1002 1811	WRF 180 1x1 AL	1x1	180x120	238x140	9.370x5.512	1.15	2.535
	71 1002 1812	WRF 180 1x2 AL	1x2	180x120	238x270	9.370x10.630	1.95	4.299
	71 1002 1813	WRF 180 1x3 AL	1x3	180x120	238x400	9.370x15.748	2.76	6.085
	71 1002 1814	WRF 180 1x4 AL	1x4	180x120	238x530	9.370x20.866	3.57	7.862
	71 1002 1815	WRF 180 1x5 AL	1x5	180x120	238x660	9.370x26.984	4.37	9.634
	71 1002 1816	WRF 180 1x6 AL	1x6	180x120	238x790	9.370x31.102	5.18	11.409
	71 1002 1821	WRF 180 2x1 AL	2x1	180x120	466x140	18.347x5.512	2.08	4.583
	71 1002 1822	WRF 180 2x2 AL	2x2	180x120	476x270	18.740x10.630	3.92	8.640
	71 1002 1823	WRF 180 2x3 AL	2x3	180x120	476x400	18.740x15.748	5.55	12.242
	71 1002 1824	WRF 180 2x4 AL	2x4	180x120	476x530	18.740x20.866	7.29	16.072

WMR series								
PICTURE DISEGNO	CODE CODICE	ARTICLE ARTICOLO	OPENINGS APERTURE TELAIO	PACKING SPACE SPAZIO DI RIEMPIMENTO	EXTERNAL NOMINAL DIMENSIONS		WEIGHT	
					mm	in	kg	lb
	71 1002 1825	WRF 180 2x5 AL	2x5	180x120	476x660	18.740x25.984	9.03	19.901
	71 1002 1826	WRF 180 2x6 AL	2x6	180x120	476x790	18.740x31.102	10.76	23.731
	71 1002 1831	WRF 180 3x1 AL	3x1	180x120	694x140	27.323x5.512	3.01	6.640
	71 1002 2411	WRF 240 1x1 AL	1x1	240x120	298x140	11.732x5.512	1.34	2.954
	71 1002 2412	WRF 240 1x2 AL	1x2	240x120	298x270	11.733x10.630	2.24	4.938
	71 1002 2413	WRF 240 1x3 AL	1x3	240x120	298x400	11.732x15.748	3.15	6.945
	71 1002 2414	WRF 240 1x4 AL	1x4	240x120	298x530	11.732x20.866	4.06	8.940
	71 1002 2415	WRF 240 1x5 AL	1x5	240x120	298x660	11.732x25.984	4.96	10.935
	71 1002 2416	WRF 240 1x6 AL	1x6	240x120	298x790	11.732x31.102	5.87	12.930
	71 1002 2421	WRF 240 2x1 AL	2x1	240x120	586x141	23.071x5.512	2.47	5.441
	71 1002 2431	WRF 240 3x1 AL	3x1	240x120	874x141	34.409x5.512	3.60	7.926

WRF2

WallMax® Rectangular Frame 2

WallMax® Rectangular Frame 2

WallMax® WRF2 frames are insulating solutions with 200mm depth, designed and especially recommended where high levels of fire integrity and performance are demanded.

A double set of modules, mounted on each side of the frame, with a layer of insulating material in between them, guarantees elevated tightness and resistance.

WRF2 solutions are designed for installation through welding.

Cornice Rettangolare 2 WallMax®

Le cornici WRF2 WallMax® sono soluzioni di passaggio cavi profonde 200mm, pensate per applicazioni dove è essenziale un alto livello di integrità al fuoco.

La profondità delle cornici WRF2 permette di utilizzare un doppio set di moduli WMR, uno su ciascun lato del telaio, montati attorno ad uno strato intermedio di materiale isolante a garanzia di una sigillatura totale, anche in condizioni di estrema pressione.

I telai WRF2 sono pensati per soluzioni di installazione tramite saldatura.





WallMax® WRF2 Frame

WRF2 frames are used with a double set of WMR modules and accessories, one on each side of the frame, to develop extremely high fire resistant sealing applications.

Cornice WRF2 WallMax®

Le cornici WRF2 si devono utilizzare con un doppio set di moduli e accessori della linea WMR per ottenere soluzioni di sigillatura estremamente resistenti al fuoco.

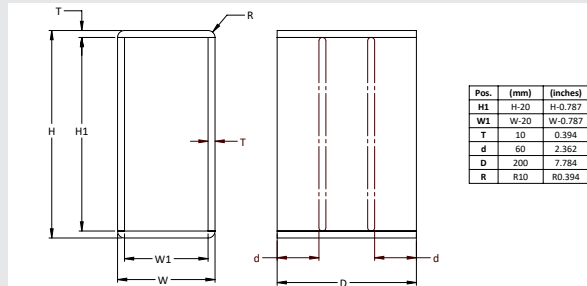































MATERIALS	MATERIALI
Primed Steel	Acciaio con prima mano antiruggine
SS AISI 316 L	Acciaio inox resistente agli acidi
Other materials available upon request	Disponibile in altri materiali su richiesta

























DATASHEET PAGE: 149

To be used in combination with/utilizzate in combinazione con

WMR series									
PICTURE	CODE	ARTICLE	OPENINGS	PACKING SPACE	EXTERNAL NOMINAL DIMENSIONS			WEIGHT	
DISEGNO	CODICE	ARTICOLO	APERTURE	SPAZIO DI	DIMENSIONI ESTERNE NOMINALI			PESO	
			TELAIO	RIEMPIMENTO	HxW (D=200mm)			kg	lb
				mm	mm	in			
	71 1080 0611	WRF2 60 1x1 Primed	1x1	60x120	118x140	4.646x5.512	7.29	16.074	
	71 1080 0612	WRF2 60 1x2 Primed	1x2	60x120	118x270	4.646x10.630	13.19	29.075	
	71 1080 0613	WRF2 60 1x3 Primed	1x3	60x120	118x400	4.646x15.748	19.09	42.075	
	71 1080 0614	WRF2 60 1x4 Primed	1x4	60x120	118x530	4.646x20.866	24.98	55.076	
	71 1080 0615	WRF2 60 1x5 Primed	1x5	60x120	118x660	4.646x25.984	30.88	68.077	
	71 1080 0616	WRF2 60 1x6 Primed	1x6	60x120	118x790	4.646x31.102	36.77	81.077	
	71 1080 1211	WRF2 120 1x1 Primed	1x1	120x120	178x140	7.008x5.512	9.16	20.203	
	71 1080 1212	WRF2 120 1x2 Primed	1x2	120x120	178x270	7.008x10.630	16.00	35.265	
	71 1080 1213	WRF2 120 1x3 Primed	1x3	120x120	178x400	7.008x15.748	22.83	50.329	
	71 1080 1214	WRF2 120 1x4 Primed	1x4	120x120	178x530	7.008x20.866	29.66	65.394	
	71 1080 1215	WRF2 120 1x5 Primed	1x5	120x120	178x660	7.008x25.984	36.49	0.455	
	71 1080 1216	WRF2 120 1x6 Primed	1x6	120x120	178x790	7.008x31.102	43.33	95.520	
	71 1080 1217	WRF2 120 1x7 Primed	1x7	120x120	178x920	7.008x36.221	50.16	110.582	

WMR series									
PICTURE	CODE	ARTICLE	OPENINGS	PACKING SPACE	EXTERNAL NOMINAL DIMENSIONS			WEIGHT	
DISEGNO	CODICE	ARTICOLO	APERTURE	SPAZIO DI	DIMENSIONI ESTERNE NOMINALI			PESO	
			TELAIO	RIEMPIMENTO	HxW (D=200mm)			kg	lb
				mm	mm	in			
	71 1080 1218	WRF2 120 1x8 Primed	1x8	120x120	178x1050	7.008x41.339	56.99	125.646	
	71 1080 1219	WRF2 120 1x9 Primed	1x9	120x120	178x1180	7.008x46.457	63.82	140.708	
	71 1080 1221	WRF2 120 2x1 Primed	2x1	120x120	346x140	13.622x5.512	15.55	34.275	
	71 1080 1222	WRF2 120 2x2 Primed	2x2	120x120	356x270	14.016x10.630	29.30	64.584	
	71 1080 1223	WRF2 120 2x3 Primed	2x3	120x120	356x400	14.016x15.748	40.70	89.726	
	71 1080 1224	WRF2 120 2x4 Primed	2x4	120x120	356x530	14.016x20.866	53.28	117.451	
	71 1080 1225	WRF2 120 2x5 Primed	2x5	120x120	356x660	14.016x25.984	65.85	145.177	
	71 1080 1226	WRF2 120 2x6 Primed	2x6	120x120	356x790	14.016x31.102	78.43	172.902	
	71 1080 1227	WRF2 120 2x7 Primed	2x7	120x120	356x920	14.016x36.221	91.00	200.627	
	71 1080 1228	WRF2 120 2x8 Primed	2x8	120x120	356x1050	14.016x41.339	103.58	228.353	
	71 1080 1231	WRF2 120 3x1 Primed	3x1	120x120	514x140	20.236x5.512	22.30	49.152	
	71 1080 1232	WRF2 120 3x2 Primed	3x2	120x120	534x270	21.220x10.630	43.89	96.761	
	71 1080 1233	WRF2 120 3x3 Primed	3x3	120x120	534x400	21.220x15.748	61.12	134.738	
	71 1080 1234	WRF2 120 3x4 Primed	3x4	120x120	534x530	21.220x20.866	80.53	177.532	
	71 1080 1235	WRF2 120 3x5 Primed	3x5	120x120	534x660	21.220x25.984	99.94	220.323	
	71 1080 1236	WRF2 120 3x6 Primed	3x6	120x120	534x790	21.220x31.102	119.35	263.117	
	71 1080 1811	WRF2 180 1x1 Primed	1x1	180x120	238x140	9.370x5.512	11.04	24.328	
	71 1080 1812	WRF2 180 1x2 Primed	1x2	180x120	238x270	9.370x10.630	18.80	41.456	
	71 1080 1813	WRF2 180 1x3 Primed	1x3	180x120	238x400	9.370x15.748	26.57	58.583	
	71 1080 1814	WRF2 180 1x4 Primed	1x4	180x120	238x530	9.370x20.866	34.34	75.711	
	71 1080 1815	WRF2 180 1x5 Primed	1x5	180x120	238x660	9.370x26.984	42.11	92.839	
	71 1080 1816	WRF2 180 1x6 Primed	1x6	180x120	238x790	9.370x31.102	57.65	127.094	
	71 1080 1817	WRF2 180 1x7 Primed	1x7	180x120	238x920	9.370x36.221	65.42	144.222	
	71 1080 1818	WRF2 180 1x8 Primed	1x8	180x120	238x1050	9.370x41.339	73.19	161.350	
	71 1080 1819	WRF2 180 1x9 Primed	1x9	180x120	238x1180	9.370x46.457	80.96	178.477	
	71 1080 1821	WRF2 180 2x1 Primed	2x1	180x120	466x140	18.347x5.512	19.08	42.066	
	71 1080 1822	WRF2 180 2x2 Primed	2x2	180x120	476x270	18.740x10.630	33.87	74.677	
	71 1080 1823	WRF2 180 2x3 Primed	2x3	180x120	476x400	18.740x15.748	46.48	102.471	
	71 1080 1824	WRF2 180 2x4 Primed	2x4	180x120	476x530	18.740x20.866	60.18	132.674	
	71 1080 1825	WRF2 180 2x5 Primed	2x5	180x120	476x660	18.740x25.984	73.88	162.875	
	71 1080 1826	WRF2 180 2x6 Primed	2x6	180x120	476x790	18.740x31.102	87.58	193.079	

WMR series										
PICTURE DISEGNO	CODE CODICE	ARTICLE ARTICOLO	OPENINGS APERTURE TELAIO	PACKING SPACE SPAZIO DI RIEMPIMENTO	EXTERNAL NOMINAL DIMENSIONS			WEIGHT		
					mm	mm	in	kg	lb	
	71 1080 1827	WRF2 180 2x7 Primed	2x7	180x120	476x920	18.740x36.221	101.28	223.280		
	71 1080 1828	WRF2 180 2x8 Primed	2x8	180x120	476x1050	18.740x41.339	114.98	253.483		
	71 1080 1829	WRF2 180 2x9 Primed	2x9	180x120	476x1180	18.740x46.457	128.68	283.684		
	71 1080 1820	WRF2 180 2x10 Primed	2x10	180x120	476x1310	18.740x51.575	142.38	313.888		
	71 1080 1831	WRF2 180 3x1 Primed	3x1	180x120	694x140	27.323x5.512	26.10	57.540		
	71 1080 2411	WRF2 240 1x1 Primed	1x1	240x120	298x140	11.732x5.512	12.91	28.455		
	71 1080 2412	WRF2 240 1x2 Primed	1x2	240x120	298x270	11.733x10.630	21.61	47.646		
	71 1080 2413	WRF2 240 1x3 Primed	1x3	240x120	298x400	11.732x15.748	30.32	66.838		
	71 1080 2414	WRF2 240 1x4 Primed	1x4	240x120	298x530	11.732x20.866	39.02	86.029		
	71 1080 2415	WRF2 240 1x5 Primed	1x5	240x120	298x660	11.732x25.984	47.73	105.220		
	71 1080 2416	WRF2 240 1x6 Primed	1x6	240x120	298x790	11.732x31.102	56.43	124.411		
	71 1080 2421	WRF2 240 2x1 Primed	2x1	240x120	586x140	23.071x5.512	22.62	49.860		
	71 1080 2422	WRF2 240 2x2 Primed	2x2	240x120	596x270	23.465x10.630	38.53	84.944		
	71 1080 2423	WRF2 240 2x3 Primed	2x3	240x120	596x400	23.465x15.748	52.26	115.216		
	71 1080 2424	WRF2 240 2x4 Primed	2x4	240x120	596x530	23.465x20.866	67.08	147.894		
	71 1080 2425	WRF2 240 2x5 Primed	2x5	240x120	596x660	23.465x25.984	81.91	180.572		
	71 1080 2426	WRF2 240 2x6 Primed	2x6	240x120	596x790	23.465x31.102	96.73	213.250		
	71 1080 2427	WRF2 240 2x7 Primed	2x7	240x120	596x920	23.465x36.221	111.55	245.928		
	71 1080 2428	WRF2 240 2x8 Primed	2x8	240x120	596x1050	23.465x41.339	126.37	278.606		
	71 1080 2429	WRF2 240 2x9 Primed	2x9	240x120	596x1180	23.465x46.457	141.20	311.284		
	71 1080 2420	WRF2 240 2x10 Primed	2x10	240x120	596x1310	23.465x51.575	156.02	343.962		
	71 1080 2431	WRF2 240 3x1 Primed	3x1	240x120	874x140	34.409x5.512	32.90	72.528		
	71 1081 0611	WRF2 60 1x1 AISI 316	1x1	60x120	118x140	4.646x5.512	7.48	16.491		
	71 1081 0612	WRF2 60 1x2 AISI 316	1x2	60x120	118x270	4.646x10.630	13.53	29.829		
	71 1081 0613	WRF2 60 1x3 AISI 316	1x3	60x120	118x400	4.646x15.748	19.57	43.145		
	71 1081 0614	WRF2 60 1x4 AISI 316	1x4	60x120	118x530	4.646x20.866	25.62	56.471		
	71 1081 0615	WRF2 60 1x5 AISI 316	1x5	60x120	118x660	4.646x25.984	31.66	69.798		
	71 1081 0616	WRF2 60 1x6 AISI 316	1x6	60x120	118x790	4.646x31.102	37.71	83.125		
	71 1081 1211	WRF2 120 1x1 AISI 316	1x1	120x120	178x140	7.008x5.512	9.40	20.724		
	71 1081 1212	WRF2 120 1x2 AISI 316	1x2	120x120	178x270	7.008x10.630	16.41	36.178		
	71 1081 1213	WRF2 120 1x3 AISI 316	1x3	120x120	178x400	7.008x15.748	23.41	51.610		

WMR series										
PICTURE DISEGNO	CODE CODICE	ARTICLE ARTICOLO	OPENINGS APERTURE TELAIO	PACKING SPACE SPAZIO DI RIEMPIMENTO	EXTERNAL NOMINAL DIMENSIONS			WEIGHT		
					mm	mm	in	kg	lb	
	71 1081 1214	WRF2120 1x4 AISI 316	1x4	120x120	178x530	7.008x20.866	30.42	67.054		
	71 1081 1215	WRF2 120 1x5 AISI 316	1x5	120x120	178x660	7.008x25.984	37.42	82.497		
	71 1081 1216	WRF2 120 1x6 AISI 316	1x6	120x120	178x790	7.008x31.102	44.43	97.940		
	71 1081 1221	WRF2 120 2x1 AISI 316	2x1	120x120	346x140	13.622x5.512	15.95	35.155		
	71 1081 1231	WRF2 120 3x1 AISI 316	3x1	120x120	514x140	20.236x5.512	22.87	50.413		
	71 1081 1811	WRF2 180 1x1 AISI 316	1x1	180x120	238x140	9.370x5.512	11.32	24.956		
	71 1081 1812	WRF2 180 1x2 AISI 316	1x2	180x120	238x270	9.370x10.630	19.29	42.527		
	71 1081 1813	WRF2 180 1x3 AISI 316	1x3	180x120	238x400	9.370x15.748	27.25	60.076		
	71 1081 1814	WRF2 180 1x4 AISI 316	1x4	180x120	238x530	9.370x20.866	35.22	77.636		
	71 1081 1815	WRF2 180 1x5 AISI 316	1x5	180x120	238x660	9.370x25.984	43.18	95.196		
	71 1081 1816	WRF2 180 1x6 AISI 316	1x6	180x120	238x790	9.370x31.102	51.15	112.755		
	71 1081 1821	WRF2 180 2x1 AISI 316	2x1	180x120	466x140	18.347x5.512	19.57	43.147		
	71 1081 1822	WRF2 180 2x2 AISI 316	2x2	180x120	476x270	18.740x10.630	34.74	76.591		
	71 1081 1823	WRF2 180 2x3 AISI 316	2x3	180x120	476x400	18.740x15.748	47.67	105.099		
	71 1081 1824	WRF2 180 2x4 AISI 316	2x4	180x120	476x530	18.740x20.866	61.72	136.075		
	71 1081 1825	WRF2 180 2x5 AISI 316	2x5	180x120	476x660	18.740x25.984	75.77	167.051		
	71 1081 1826	WRF2 180 2x6 AISI 316	2x6	180x120	476x790	18.740x31.102	89.82	198.027		
	71 1081 2411	WRF2 240 1x1 AISI 316	1x1	240x120	298x140	11.732x5.512	13.24	29.187		
	71 1081 2412	WRF2 240 1x2 AISI 316	1x2	240x120	298x270	11.733x10.630	22.17	48.870		
	71 1081 2413	WRF2 240 1x3 AISI 316	1x3	240x120	298x400	11.732x15.748	31.10	68.553		
	71 1081 2414	WRF2 240 1x4 AISI 316	1x4	240x120	298x530	11.732x20.866	40.02	88.236		
	71 1081 2415	WRF2 240 1x5 AISI 316	1x5	240x120	298x660	11.732x25.984	48.95	107.918		
	71 1081 2416	WRF2 240 1x6 AISI 316	1x6	240x120	298x790	11.732x31.102	57.88	127.601		
	71 1081 2421	WRF2 240 2x1 AISI 316	2x1	240x120	586x140	23.071x5.512	23.20	51.138		
	71 1081 2431	WRF2 240 3x1 AISI 316	3x1	240x120	874x140	34.409x5.512	33.74	74.388		

WRFD

WallMax® Rectangular Frame Depth

WallMax® Rectangular Frame Depth

WallMax® WRFD frames are mounting solutions with 100mm depth, designed and especially conceived for applications where flexibility is required.

Angled installations are made possible thanks to the extended depth of this frame. A large variety of combinations is available in terms of openings, sizes and materials, allowing to satisfy specific customer needs. WRFD solutions are designed for installation through welding.

Cornice Rettangolare Profonda WallMax®

Le cornici WRFD WallMax® sono soluzioni di passaggio cavi profonde 100mm, pensate per applicazioni dove la flessibilità è essenziale.

Installazioni ad angolo sono possibili grazie alla profondità della cornice.

WallMax® offre un'ampia gamma di combinazioni, con la possibilità di personalizzare le cornici sia in termini di numero di aperture che di scelta di materiali. I telai WRFD sono pensati per soluzioni di installazione tramite saldatura.



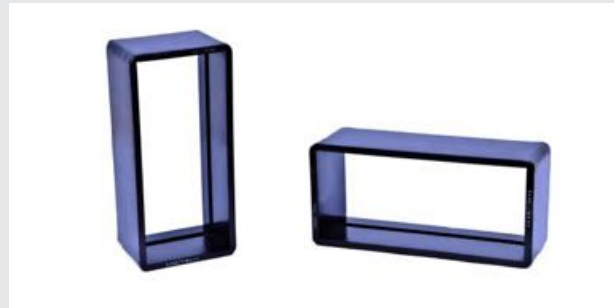

WallMax® WRFD Frame

WRFD frames are used in combination with WMR series and accessories.

Cornice WRFD WallMax®

Le cornici WRFD sono utilizzate in combinazione con i moduli e gli accessori della linea WMR.

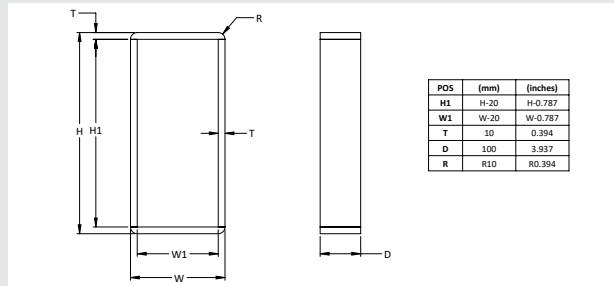

To be used in combination with/utilizzate in combinazione con

WMR series									
PICTURE	CODE	ARTICLE	OPENINGS	PACKING SPACE	EXTERNAL NOMINAL DIMENSIONS		WEIGHT		
DISEGNO	CODICE	ARTICOLO	APERTURE TELAIO	SPAZIO DI RIEMPIMENTO	DIMENSIONI ESTERNE NOMINALI HxW (D=100mm)		PESO		
				mm	mm	in	kg	lb	
	71 1070 0611	WRFD 60 1x1 Primed	1x1	60x120	118x140	4.646x5.512	3.52	7.751	
	71 1070 0612	WRFD 60 1x2 Primed	1x2	60x120	118x270	4.646x10.630	6.60	14.551	
	71 1070 0613	WRFD 60 1x3 Primed	1x3	60x120	118x400	4.646x15.748	9.55	21.043	
	71 1070 0614	WRFD 60 1x4 Primed	1x4	60x120	118x530	4.646x20.866	12.49	27.536	
	71 1070 0615	WRFD 60 1x5 Primed	1x5	60x120	118x660	4.646x25.984	15.44	34.039	
	71 1070 0616	WRFD 60 1x6 Primed	1x6	60x120	118x790	4.646x31.102	18.39	40.532	
	71 1070 1211	WRFD 120 1x1 Primed	1x1	120x120	178x140	7.008x5.512	4.58	10.097	
	71 1070 1212	WRFD 120 1x2 Primed	1x2	120x120	178x270	7.008x10.630	8.00	17.637	
	71 1070 1213	WRFD 120 1x3 Primed	1x3	120x120	178x400	7.008x15.748	11.42	25.166	
	71 1070 1214	WRFD 120 1x4 Primed	1x4	120x120	178x530	7.008x20.866	14.83	32.695	
	71 1070 1215	WRFD 120 1x5 Primed	1x5	120x120	178x660	7.008x25.984	18.25	40.223	
	71 1070 1216	WRFD 120 1x6 Primed	1x6	120x120	178x790	7.008x31.102	21.67	47.763	

MATERIALS	MATERIALI
Primed Steel	Acciaio con prima mano antiruggine
SS AISI 316 L	Acciaio inox resistente agli acidi
Other materials available upon request	Disponibile in altri materiali su richiesta

DATASHEET PAGE: 150

WMR series									
PICTURE	CODE	ARTICLE	OPENINGS	PACKING SPACE	EXTERNAL NOMINAL DIMENSIONS		WEIGHT		
DISEGNO	CODICE	ARTICOLO	APERTURE TELAIO	SPAZIO DI RIEMPIMENTO	DIMENSIONI ESTERNE NOMINALI HxW (D=100mm)		PESO		
				mm	mm	in	kg	lb	
	71 1070 1217	WRFD 120 1x7 Primed	1x7	120x120	178x920	7.008x36.221	25.08	55.292	
	71 1070 1218	WRFD 120 1x8 Primed	1x8	120x120	178x1050	7.008x41.339	28.50	62.821	
	71 1070 1219	WRFD 120 1x9 Primed	1x9	120x120	178x1180	7.008x46.457	31.91	70.350	
	71 1070 1221	WRFD 120 2x1 Primed	2x1	120x120	346x140	13.622x5.512	7.78	17.141	
	71 1070 1222	WRFD 120 2x2 Primed	2x2	120x120	356x270	14.016x10.630	14.65	32.298	
	71 1070 1223	WRFD 120 2x3 Primed	2x3	120x120	356x400	14.016x15.748	20.35	44.864	
	71 1070 1224	WRFD 120 2x4 Primed	2x4	120x120	356x530	14.016x20.866	26.64	58.731	
	71 1070 1225	WRFD 120 2x5 Primed	2x5	120x120	356x660	14.016x25.984	32.93	72.587	
	71 1070 1226	WRFD 120 2x6 Primed	2x6	120x120	356x790	14.016x31.102	39.22	86.454	
	71 1070 1227	WRFD120 2x7 Primed	2x7	120x120	356x920	14.016x36.221	45.50	100.310	
	71 1070 1228	WRFD 120 2x8 Primed	2x8	120x120	356x1050	14.016x41.339	51.79	114.177	
	71 1070 1231	WRFD 120 3x1 Primed	3x1	120x120	514x140	20.236x5.512	11.15	24.582	
	71 1070 1232	WRFD 120 3x2 Primed	3x2	120x120	534x270	21.220x10.630	21.95	48.380	
	71 1070 1233	WRFD 120 3x3 Primed	3x3	120x120	534x400	21.220x15.748	30.56	67.373	
	71 1070 1234	WRFD 120 3x4 Primed	3x4	120x120	534x530	21.220x20.866	40.27	88.769	
	71 1070 1235	WRFD 120 3x5 Primed	3x5	120x120	534x660	21.220x25.984	49.97	110.165	
	71 1070 1236	WRFD 120 3x6 Primed	3x6	120x120	534x790	21.220x31.102	59.68	131.561	
	71 1070 1811	WRFD 180 1x1 Primed	1x1	180x120	238x140	9.370x5.512	5.52	12.170	
	71 1070 1812	WRFD 180 1x2 Primed	1x2	180x120	238x270	9.370x10.630	9.40	20.724	
	71 1070 1813	WRFD 180 1x3 Primed	1x3	180x120	238x400	9.370x15.748	13.29	29.288	
	71 1070 1814	WRFD 180 1x4 Primed	1x4	180x120	238x530	9.370x20.866	17.17	37.853	
	71 1070 1815	WRFD 180 1x5 Primed	1x5	180x120	238x660	9.370x26.984	21.06	46.418	
	71 1070 1816	WRFD 180 1x6 Primed	1x6	180x120	238x790	9.370x31.102	28.83	63.548	
	71 1070 1817	WRFD 180 1x7 Primed	1x7	180x120	238x920	9.370x36.221	32.71	72.113	
	71 1070 1818	WRFD 180 1x8 Primed	1x8	180x120	238x1050	9.370x41.339	36.60	80.678	
	71 1070 1819	WRFD 180 1x9 Primed	1x9	180x120	238x1180	9.370x46.457	40.48	89.243	
	71 1070 1821	WRFD 180 2x1 Primed	2x1	180x120	466x140	18.347x5.512	9.54	21.032	
	71 1070 1822	WRFD 180 2x2 Primed	2x2	180x120	476x270	18.740x10.630	16.94	37.335	
	71 1070 1823	WRFD 180 2x3 Primed	2x3	180x120	476x400	18.740x15.748	23.24	51.235	
	71 1070 1824	WRFD 180 2x4 Primed	2x4	180x120	476x530	18.740x20.866	30.09	66.337	
	71 1070 1825	WRFD 180 2x5 Primed	2x5	180x120	476x660	18.740x25.984	36.94	81.439	

WMR series									
PICTURE DISEGNO	CODE CODICE	ARTICLE ARTICOLO	OPENINGS APERTURE TELAIO	PACKING SPACE SPAZIO DI RIEMPIMENTO	EXTERNAL NOMINAL DIMENSIONS DIMENSIONI ESTERNE NOMINALI			WEIGHT PESO	
					HxW (D=100mm)	mm	in	kg	lb
	71 1070 1826	WRFD 180 2x6 Primed	2x6	180x120	476x790	18.740x31.102	43.79	96.540	
	71 1070 1827	WRFD 180 2x7 Primed	2x7	180x120	476x920	18.740x36.221	50.64	111.642	
	71 1070 1828	WRFD 180 2x8 Primed	2x8	180x120	476x1050	18.740x41.339	57.49	126.744	
	71 1070 1829	WRFD 180 2x9 Primed	2x9	180x120	476x1180	18.740x46.457	64.34	141.845	
	71 1070 1820	WRFD 180 2x10 Primed	2x10	180x120	476x1310	18.740x51.575	71.19	156.947	
	71 1070 1831	WRFD 180 3x1 Primed	3x1	180x120	694x140	27.323x5.512	13.05	28.770	
	71 1070 2411	WRFD 240 1x1 Primed	1x1	240x120	298x140	11.732x5.512	6.17	13.594	
	71 1070 2412	WRFD 240 1x2 Primed	1x2	240x120	298x270	11.733x10.630	10.81	23.821	
	71 1070 2413	WRFD 240 1x3 Primed	1x3	240x120	298x400	11.732x15.748	15.16	33.422	
	71 1070 2414	WRFD 240 1x4 Primed	1x4	240x120	298x530	11.732x20.866	19.51	43.012	
	71 1070 2415	WRFD 240 1x5 Primed	1x5	240x120	298x660	11.732x25.984	23.87	52.613	
	71 1070 2416	WRFD 240 1x6 Primed	1x6	240x120	298x790	11.732x31.102	28.22	62.203	
	71 1070 2421	WRFD 240 2x1 Primed	2x1	240x120	586x140	23.071x5.512	11.31	24.934	
	71 1070 2422	WRFD 240 2x2 Primed	2x2	240x120	596x270	23.465x10.630	19.27	42.472	
	71 1070 2423	WRFD 240 2x3 Primed	2x3	240x120	596x400	23.465x15.748	26.13	57.607	
	71 1070 2424	WRFD 240 2x4 Primed	2x4	240x120	596x530	23.465x20.866	33.54	73.943	
	71 1070 2425	WRFD 240 2x5 Primed	2x5	240x120	596x660	23.465x25.984	40.96	90.290	
	71 1070 2426	WRFD 240 2x6 Primed	2x6	240x120	596x790	23.465x31.102	48.37	106.627	
	71 1070 2427	WRFD 240 2x7 Primed	2x7	240x120	596x920	23.465x36.221	55.78	122.963	
	71 1070 2428	WRFD 240 2x8 Primed	2x8	240x120	596x1050	23.465x41.339	63.19	139.299	
	71 1070 2429	WRFD 240 2x9 Primed	2x9	240x120	596x1180	23.465x46.457	70.60	155.646	
	71 1070 2420	WRFD 240 2x10 Primed	2x10	240x120	596x1310	23.465x51.575	78.01	171.983	
	71 1070 2431	WRFD 240 3x1 Primed	3x1	240x120	874x140	34.409x5.512	16.45	36.450	
	71 1071 0611	WRFD 60 1x1 AISI 316	1x1	60x120	118x140	4.646x5.512	3.74	8.245	
	71 1071 0612	WRFD 60 1x2 AISI 316	1x2	60x120	118x270	4.646x10.630	6.77	14.914	
	71 1071 0613	WRFD 60 1x3 AISI 316	1x3	60x120	118x400	4.646x15.748	9.79	21.572	
	71 1071 0614	WRFD 60 1x4 AISI 316	1x4	60x120	118x530	4.646x20.866	12.81	28.241	
	71 1071 0615	WRFD 60 1x5 AISI 316	1x5	60x120	118x660	4.646x25.984	15.83	34.899	
	71 1071 0616	WRFD 60 1x6 AISI 316	1x6	60x120	118x790	4.646x31.102	18.86	41.568	
	71 1071 1211	WRFD 120 1x1 AISI 316	1x1	120x120	178x140	7.008x5.512	4.70	10.362	
	71 1071 1212	WRFD 120 1x2 AISI 316	1x2	120x120	178x270	7.008x10.630	8.21	18.089	

WMR series									
PICTURE DISEGNO	CODE CODICE	ARTICLE ARTICOLO	OPENINGS APERTURE TELAIO	PACKING SPACE SPAZIO DI RIEMPIMENTO	EXTERNAL NOMINAL DIMENSIONS DIMENSIONI ESTERNE NOMINALI			WEIGHT PESO	
					HxW (D=100mm)	mm	in	kg	lb
	71 1071 1213	WRFD 120 1x3 AISI 316	1x3	120x120	178x400	7.008x15.748	11.71	25.805	
	71 1071 1214	WRFD120 1x4 AISI 316	1x4	120x120	178x530	7.008x20.866	15.21	33.532	
	71 1071 1215	WRFD 120 1x5 AISI 316	1x5	120x120	178x660	7.008x25.984	18.71	41.248	
	71 1071 1216	WRFD 120 1x6 AISI 316	1x6	120x120	178x790	7.008x31.102	22.22	48.976	
	71 1071 1221	WRFD 120 2x1 AISI 316	2x1	120x120	346x140	13.622x5.512	7.98	17.582	
	71 1071 1231	WRFD 120 3x1 AISI 316	3x1	120x120	514x140	20.236x5.512	11.44	25.210	
	71 1071 1811	WRFD 180 1x1 AISI 316	1x1	180x120	238x140	9.370x5.512	5.66	12.478	
	71 1071 1812	WRFD 180 1x2 AISI 316	1x2	180x120	238x270	9.370x10.630	9.65	21.264	
	71 1071 1813	WRFD 180 1x3 AISI 316	1x3	180x120	238x400	9.370x15.748	13.63	30.049	
	71 1071 1814	WRFD 180 1x4 AISI 316	1x4	180x120	238x530	9.370x20.866	17.61	38.823	
	71 1071 1815	WRFD 180 1x5 AISI 316	1x5	180x120	238x660	9.370x26.984	21.59	47.598	
	71 1071 1816	WRFD 180 1x6 AISI 316	1x6	180x120	238x790	9.370x31.102	25.58	56.383	
	71 1071 1821	WRFD 180 2x1 AISI 316	2x1	180x120	466x140	18.347x5.512	9.79	21.572	
	71 1071 1822	WRFD 180 2x2 AISI 316	2x2	180x120	476x270	18.740x10.630	17.37	38.294	
	71 1071 1823	WRFD 180 2x3 AISI 316	2x3	180x120	476x400	18.740x15.748	23.84	52.547	
	71 1071 1824	WRFD 180 2x4 AISI 316	2x4	180x120	476x530	18.740x20.866	30.86	68.035	
	71 1071 1825	WRFD 180 2x5 AISI 316	2x5	180x120	476x660	18.740x25.984	37.89	83.522	
	71 1071 1826	WRFD 180 2x6 AISI 316	2x6	180x120	476x790	18.740x31.102	44.91	99.010	
	71 1071 2411	WRFD 240 1x1 AISI 316	1x1	240x120	298x140	11.732x5.512	6.62	14.595	
	71 1071 2412	WRFD 240 1x2 AISI 316	1x2	240x120	298x270	11.733x10.630	11.08	24.436	
	71 1071 2413	WRFD 240 1x3 AISI 316	1x3	240x120	298x400	11.732x15.748	15.55	34.282	
	71 1071 2414	WRFD 240 1x4 AISI 316	1x4	240x120	298x530	11.732x20.866	20.01	44.114	
	71 1071 2415	WRFD 240 1x5 AISI 316	1x5	240x120	298x660	11.732x25.984	24.48	53.598	
	71 1071 2416	WRFD 240 1x6 AISI 316	1x6	240x120	298x790	11.732x31.102	28.94	63.802	
	71 1071 2421	WRFD 240 2x1 AISI 316	2x1	240x120	586x140	23.071x5.512	11.60	25.574	
	71 1071 2431	WRFD 240 3x1 AISI 316	3x1	240x120	874x140	34.409x5.512	16.87	37.192	

WRFO

WallMax® Rectangular Frame Openable

WallMax® Rectangular Frame Openable

Wallmax Rectangular Frame Openable are metal structures with single wall opening. A large variety of combinations is available in terms of sizes and materials, allowing to satisfy specific customer needs.

WRFO solutions are designed for installation where cables/pipes are already in place and it is not feasible to cut them and re-installed them.

They are supplied with a partially welded side. WRFO solutions are designed for installation through welding.

Cornice Rettangolare Scomponibile WallMax®

Le Cornici Rettangolari Scomponibili Wallmax sono telai in metallo con apertura singola.

WallMax® dispone di un'ampia gamma di combinazioni per quanto riguarda la possibilità di personalizzare le cornici in termini di scelta dei materiali.

I telai WRFO sono pensati per soluzioni di installazione dove sono già presenti dei cavi o tubi e il cliente vuole evitare di tagliarli e di conseguenza rigiuntarli.

Vengono forniti con un lato non completamente saldato.

I telai WRFO sono pensati per soluzioni di installazione tramite saldatura.

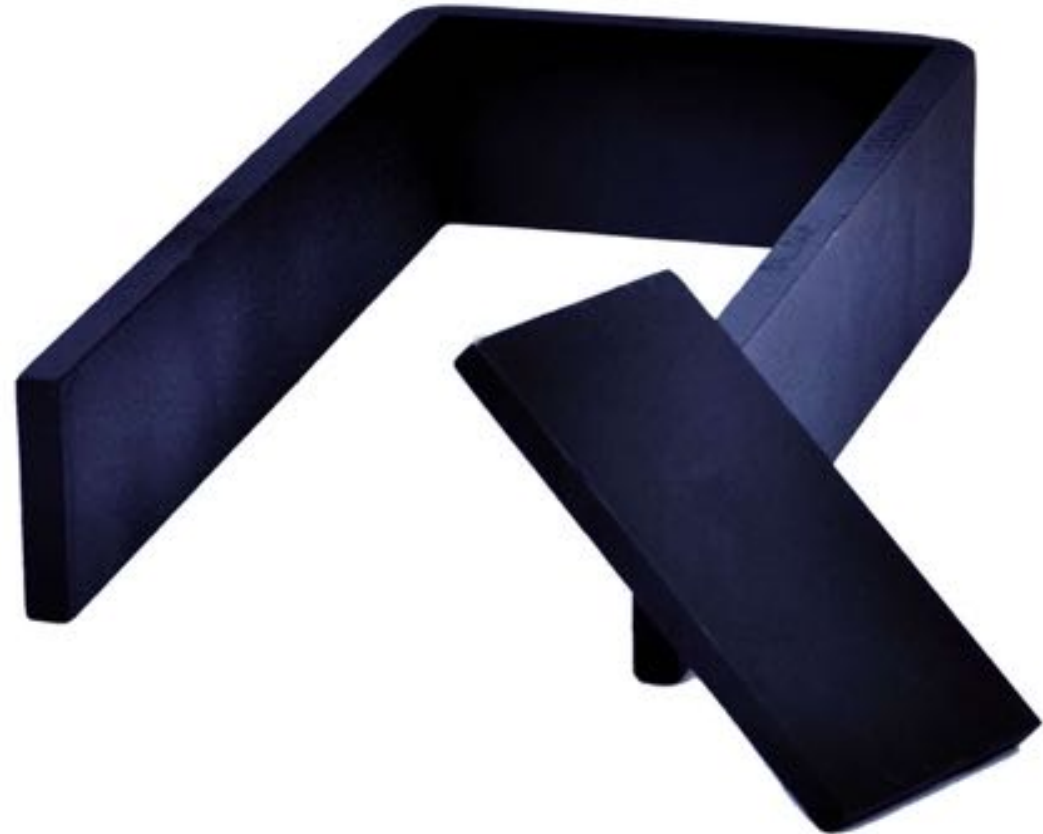

WallMax® Rectangular Frame Openable

WRFO frames are used in combination with WMR series modules and accessories to achieve customized sealing solutions. The numerous combinations of packing space allow for development of cable transit solutions specific to customer's needs.

Cornice Rettangolare Scomponibile WallMax®

Le cornici WRFO sono utilizzati in combinazione con i moduli e gli accessori della gamma WMR per offrire soluzioni di sigillatura personalizzate. Sono disponibili varie combinazioni di dimensioni con le quali si possono ottenere differenti soluzioni di passaggio cavi, a seconda delle specifiche necessità del cliente.

MATERIALS	MATERIALI
Primed Steel	Acciaio con prima mano antiruggine
SS AISI 316 L	Acciaio inox resistente agli acidi
Aluminium	Alluminio
Other materials available upon request	Disponibile in altri materiali su richiesta



DATASHEET PAGE: 151

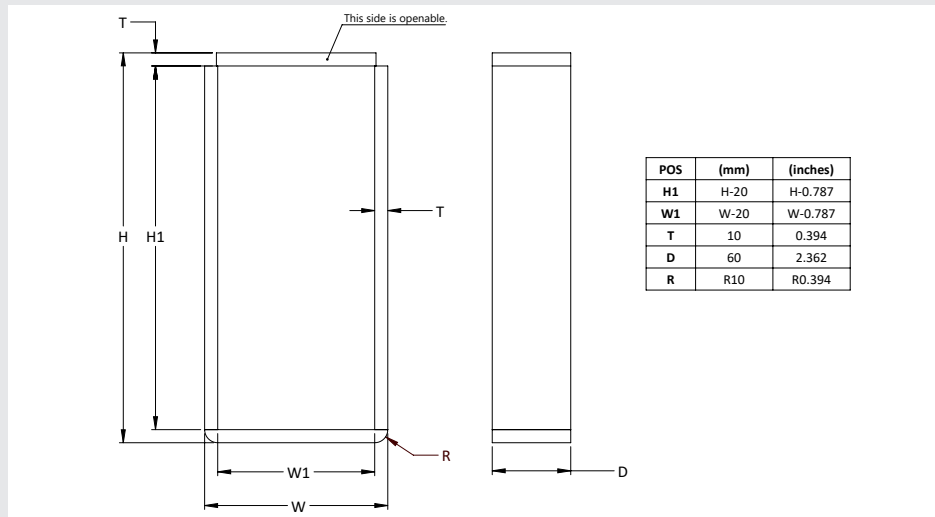

To be used in combination with/utilizzate in combinazione con

WMR series									
PICTURE DISEGNO	CODE CODICE	ARTICLE ARTICOLO	OPENINGS APERTURE TELAIO	PACKING SPACE SPAZIO DI RIEMPIMENTO mm	EXTERNAL NOMINAL DIMENSIONS DIMENSIONI ESTERNE NOMINALI HxW (D=60mm)			WEIGHT PESO	
					mm	mm	in	kg	lb
■	71 1250 0611	WRFO 60 1x1 Primed	1x1	60x120	118x140	4.646x5.512		2.12	4.674
■	71 1250 1211	WRFO 120 1x1 Primed	1x1	120x120	178x140	7.008x5.512		2.74	6.041
■	71 1250 1811	WRFO 180 1x1 Primed	1x1	180x120	238x140	9.370x5.512		3.30	7.275
■	71 1250 2411	WRFO 240 1x1 Primed	1x1	240x120	298x140	11.732x5.512		3.81	8.395
■	71 1251 0611	WRFO 60 1x1 AISI 316	1x1	60x120	118x140	4.646x5.512		2.17	4.790
■	71 1251 1211	WRFO 120 1x1 AISI 316	1x1	120x120	178x140	7.008x5.512		2.81	6.195
■	71 1251 1811	WRFO 180 1x1 AISI 316	1x1	180x120	238x140	9.370x5.512		3.39	7.473
■	71 1251 2411	WRFO 240 1x1 AISI 316	1x1	240x120	298x140	11.732x5.512		3.90	8.605
■	71 1252 0611	WRFO 60 1x1 AL	1x1	60x120	118x140	4.646x5.512		0.74	1.620
■	71 1252 1211	WRFO 120 1x1 AL	1x1	120x120	178x140	7.008x5.512		0.94	2.072
■	71 1252 1811	WRFO 180 1x1 AL	1x1	180x120	238x140	9.370x5.512		1.14	2.513
■	71 1252 2411	WRFO 240 1x1 AL	1x1	240x120	298x140	11.732x5.512		1.32	2.906

WRFR

WallMax® Rectangular Frame Rounded

WallMax® Rectangular Frame Rounded

Cornice Rettangolare Arrotondata WallMax®

WallMax® Rectangular Frames Rounded are metal structures with single or multiple openings.

The rounded corners provide greater mechanical strength and reduce stress concentration and consequently the risk of cracks around the frame.

A large variety of combinations is available in terms of openings, sizes and materials, allowing to satisfy specific customer needs. WRFR solutions are designed for installation through welding.

Le Cornici Rettangolari Arrotondate WallMax® sono telai in metallo con aperture singola o multipla.

Gli angoli arrotondati forniscono una maggiore resistenza meccanica e riducono la concentrazione degli sforzi e, di conseguenza, il rischio di crepe attorno alla cornice.

WallMax® offre un'ampia gamma di combinazioni, con la possibilità di personalizzare le cornici sia in termini di numero di aperture che di scelta di materiali. I telai WRFR sono pensati per soluzioni di installazione tramite saldatura.



WallMax® Rectangular Frame Rounded

WRFR2 frames are used in combination with WMR series modules and accessories to achieve customized sealing solutions. The numerous combinations of openings and packing space allow for development of cable transit solutions specific to customer's needs.

Cornice Rettangolare Arrotondata WallMax®

Le cornici WRFR2 sono utilizzati in combinazione con i moduli e gli accessori della gamma WMR per offrire soluzioni di sigillatura personalizzate. Sono disponibili varie combinazioni di aperture e dimensioni con le quali si possono ottenere differenti soluzioni di passaggio cavi, a seconda delle specifiche necessità del cliente.



DATASHEET PAGE: 152

MATERIALS	MATERIALI
Primed Steel	Acciaio con prima mano antiruggine
SS AISI 316 L	Acciaio inox resistente agli acidi
Aluminium	Alluminio
Other materials available upon request	Disponibile in altri materiali su richiesta

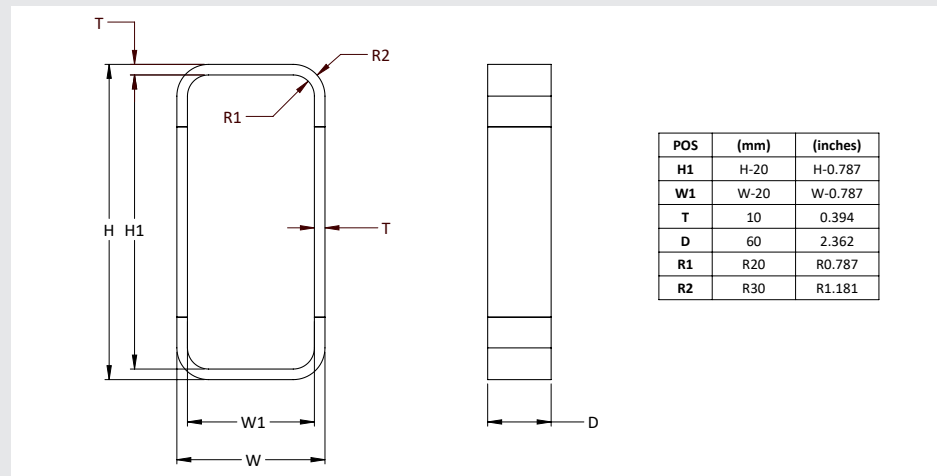











































To be used in combination with/utilizzate in combinazione con

WMR series									
PICTURE DISEGNO	CODE CODICE	ARTICLE ARTICOLO	OPENINGS APERTURE TELAIO	PACKING SPACE SPAZIO DI RIEMPIMENTO mm	EXTERNAL NOMINAL DIMENSIONS DIMENSIONI ESTERNE NOMINALI HxW (D=60mm)			WEIGHT PESO	
					mm	mm	in	kg	lb
	71 1050 0611	WRFR2 60 1x1 Primed	1x1	60x120	118x140	4.646x5.512		2.03	4.469
	71 1050 0612	WRFR2 60 1x2 Primed	1x2	60x120	118x270	4.646x10.630		3.70	8.157
	71 1050 0613	WRFR2 60 1x3 Primed	1x3	60x120	118x400	4.646x15.748		5.37	11.845
	71 1050 0614	WRFR2 60 1x4 Primed	1x4	60x120	118x530	4.646x20.866		7.05	15.534
	71 1050 0615	WRFR2 60 1x5 Primed	1x5	60x120	118x660	4.646x25.984		8.72	19.222
	71 1050 0616	WRFR2 60 1x6 Primed	1x6	60x120	118x790	4.646x31.102		10.39	22.910
	71 1050 1211	WRFR2 120 1x1 Primed	1x1	120x120	178x140	7.008x5.512		2.28	5.027
	71 1050 1212	WRFR2 120 1x2 Primed	1x2	120x120	178x270	7.008x10.630		4.34	9.575
	71 1050 1213	WRFR2 120 1x3 Primed	1x3	120x120	178x400	7.008x15.748		6.50	14.330
	71 1050 1214	WRFR2 120 1x4 Primed	1x4	120x120	178x530	7.008x20.866		8.61	18.982
	71 1050 1215	WRFR2 120 1x5 Primed	1x5	120x120	178x660	7.008x25.984		10.72	23.634
	71 1050 1216	WRFR2 120 1x6 Primed	1x6	120x120	178x790	7.008x31.102		12.83	28.285
	71 1050 1217	WRFR2 120 1x7 Primed	1x7	120x120	178x920	7.008x36.221		14.94	32.937
	71 1050 1218	WRFR2 120 1x8 Primed	1x8	120x120	178x1050	7.008x41.339		17.05	37.589
	71 1050 1219	WRFR2 120 1x9 Primed	1x9	120x120	178x1180	7.008x46.457		19.16	42.241
	71 1050 1221	WRFR2 120 2x1 Primed	2x1	120x120	346x140	13.622x5.512		4.72	10.410
	71 1050 1222	WRFR2 120 2x2 Primed	2x2	120x120	356x270	14.016x10.630		9.66	21.286
	71 1050 1223	WRFR2 120 2x3 Primed	2x3	120x120	356x400	14.016x15.748		13.76	30.344
	71 1050 1224	WRFR2 120 2x4 Primed	2x4	120x120	356x530	14.016x20.866		18.29	40.312
	71 1050 1225	WRFR2 120 2x5 Primed	2x5	120x120	356x660	14.016x25.984		22.81	50.279
	71 1050 1226	WRFR2 120 2x6 Primed	2x6	120x120	356x790	14.016x31.102		27.33	60.246
	71 1050 1227	WRFR2 120 2x7 Primed	2x7	120x120	356x920	14.016x36.221		31.85	70.213
	71 1050 1228	WRFR2 120 2x8 Primed	2x8	120x120	356x1050	14.016x41.339		36.37	80.180
	71 1050 1231	WRFR2 120 3x1 Primed	3x1	120x120	514x140	20.236x5.512		6.86	15.117
	71 1050 1232	WRFR2 120 3x2 Primed	3x2	120x120	534x270	21.220x10.630		14.69	32.388
	71 1050 1233	WRFR2 120 3x3 Primed	3x3	120x120	534x400	21.220x15.748		20.84	45.944
	71 1050 1234	WRFR2 120 3x4 Primed	3x4	120x120	534x530	21.220x20.866		27.83	61.358
	71 1050 1235	WRFR2 120 3x5 Primed	3x5	120x120	534x660	21.220x25.984		34.82	76.765
	71 1050 1236	WRFR2 120 3x6 Primed	3x6	120x120	534x790	21.220x31.102		41.81	92.175
	71 1050 1811	WRFR2 180 1x1 Primed	1x1	180x120	238x140	9.370x5.512		3.15	6.945
	71 1050 1812	WRFR2 180 1x2 Primed	1x2	180x120	238x270	9.370x10.630		5.47	12.059

WMR series									
PICTURE DISEGNO	CODE CODICE	ARTICLE ARTICOLO	OPENINGS APERTURE TELAIO	PACKING SPACE SPAZIO DI RIEMPIMENTO	EXTERNAL NOMINAL DIMENSIONS DIMENSIONI ESTERNE NOMINALI HxW (D=60mm)			WEIGHT PESO	
					mm	mm	in	kg	lb
	71 1050 1813	WRFR2 180 1x3 Primed	1x3	180x120	238x400	9.370x15.748	7.62	16.799	
	71 1050 1814	WRFR2 180 1x4 Primed	1x4	180x120	238x530	9.370x20.866	9.86	21.727	
	71 1050 1815	WRFR2 180 1x5 Primed	1x5	180x120	238x660	9.370x26.984	12.09	26.654	
	71 1050 1816	WRFR2 180 1x6 Primed	1x6	180x120	238x790	9.370x31.102	14.33	31.581	
	71 1050 1817	WRFR2 180 1x7 Primed	1x7	180x120	238x920	9.370x36.221	16.56	36.509	
	71 1050 1818	WRFR2 180 1x8 Primed	1x8	180x120	238x1050	9.370x41.339	18.80	41.436	
	71 1050 1819	WRFR2 180 1x9 Primed	1x9	180x120	238x1180	9.370x46.457	21.03	46.363	
	71 1050 1821	WRFR2 180 2x1 Primed	2x1	180x120	466x140	18.347x5.512	5.85	12.888	
	71 1050 1822	WRFR2 180 2x2 Primed	2x2	180x120	476x270	18.740x10.630	11.35	25.020	
	71 1050 1823	WRFR2 180 2x3 Primed	2x3	180x120	476x400	18.740x15.748	16.01	35.298	
	71 1050 1824	WRFR2 180 2x4 Primed	2x4	180x120	476x530	18.740x20.866	21.09	21.094	
	71 1050 1825	WRFR2 180 2x5 Primed	2x5	180x120	476x660	18.740x25.984	26.18	26.176	
	71 1050 1826	WRFR2 180 2x6 Primed	2x6	180x120	476x790	18.740x31.102	31.26	31.259	
	71 1050 1827	WRFR2 180 2x7 Primed	2x7	180x120	476x920	18.740x36.221	36.34	36.341	
	71 1050 1828	WRFR2 180 2x8 Primed	2x8	180x120	476x1050	18.740x41.339	42.42	41.424	
	71 1050 1829	WRFR2 180 2x9 Primed	2x9	180x120	476x1180	18.740x46.457	46.51	46.506	
	71 1050 1820	WRFR2 180 2x10 Primed	2x10	180x120	476x1310	18.740x51.575	51.59	51.589	
	71 1050 1831	WRFR2 180 3x1 Primed	3x1	180x120	694x140	27.323x5.512	8.54	8.541	
	71 1050 2411	WRFR2 240 1x1 Primed	1x1	240x120	298x140	11.732x5.512	3.71	8.184	
	71 1050 2412	WRFR2 240 1x2 Primed	1x2	240x120	298x270	11.733x10.630	6.23	13.735	
	71 1050 2413	WRFR2 240 1x3 Primed	1x3	240x120	298x400	11.732x15.748	8.75	19.290	
	71 1050 2414	WRFR2 240 1x4 Primed	1x4	240x120	298x530	11.732x20.866	11.27	24.844	
	71 1050 2415	WRFR2 240 1x5 Primed	1x5	240x120	298x660	11.732x25.984	13.79	30.397	
	71 1050 2416	WRFR2 240 1x6 Primed	1x6	240x120	298x790	11.732x31.102	16.31	35.951	
	71 1050 2421	WRFR2 240 2x1 Primed	2x1	240x120	586x140	23.071x5.512	6.97	15.364	
	71 1050 2422	WRFR2 240 2x2 Primed	2x2	240x120	596x270	23.465x10.630	13.03	28.735	
	71 1050 2423	WRFR2 240 2x3 Primed	2x3	240x120	596x400	23.465x15.748	18.26	40.250	
	71 1050 2424	WRFR2 240 2x4 Primed	2x4	240x120	596x530	23.465x20.866	23.90	52.693	
	71 1050 2425	WRFR2 240 2x5 Primed	2x5	240x120	596x660	23.465x25.984	29.55	65.136	
	71 1050 2426	WRFR2 240 2x6 Primed	2x6	240x120	596x790	23.465x31.102	35.19	77.578	
	71 1050 2427	WRFR2 240 2x7 Primed	2x7	240x120	596x920	23.465x36.221	40.83	90.021	

WMR series									
PICTURE DISEGNO	CODE CODICE	ARTICLE ARTICOLO	OPENINGS APERTURE TELAIO	PACKING SPACE SPAZIO DI RIEMPIMENTO	EXTERNAL NOMINAL DIMENSIONS DIMENSIONI ESTERNE NOMINALI HxW (D=60mm)			WEIGHT PESO	
					mm	mm	in	kg	lb
	71 1050 2428	WRFR2 240 2x8 Primed	2x8	240x120	596x1050	23.465x41.339	46.48	102.464	
	71 1050 2429	WRFR2 240 2x9 Primed	2x9	240x120	596x1180	23.465x46.457	52.12	114.907	
	71 1050 2420	WRFR2 240 2x10 Primed	2x10	240x120	596x1310	23.465x51.575	57.77	127.350	
	71 1050 2431	WRFR2 240 3x1 Primed	3x1	240x120	874x140	34.409x5.512	10.23	22.544	
	71 1051 0611	WRFR2 60 1x1 AISI 316	1x1	60x120	118x140	4.646x5.512	2.08	4.586	
	71 1051 0612	WRFR2 60 1x2 AISI 316	1x2	60x120	118x270	4.646x10.630	3.80	8.378	
	71 1051 0613	WRFR2 60 1x3 AISI 316	1x3	60x120	118x400	4.646x15.748	5.52	12.170	
	71 1051 0614	WRFR2 60 1x4 AISI 316	1x4	60x120	118x530	4.646x20.866	7.24	15.961	
	71 1051 0615	WRFR2 60 1x5 AISI 316	1x5	60x120	118x660	4.646x25.984	8.96	19.753	
	71 1051 0616	WRFR2 60 1x6 AISI 316	1x6	60x120	118x790	4.646x31.102	10.68	23.545	
	71 1051 1211	WRFR2 120 1x1 AISI 316	1x1	120x120	178x140	7.008x5.512	2.65	5.842	
	71 1051 1212	WRFR2 120 1x2 AISI 316	1x2	120x120	178x270	7.008x10.630	4.78	10.543	
	71 1051 1213	WRFR2 120 1x3 AISI 316	1x3	120x120	178x400	7.008x15.748	6.67	14.705	
	71 1051 1214	WRFR2 120 1x4 AISI 316	1x4	120x120	178x530	7.008x20.866	7.24	15.961	
	71 1051 1215	WRFR2 120 1x5 AISI 316	1x5	120x120	178x660	7.008x25.984	8.96	19.753	
	71 1051 1216	WRFR2 120 1x6 AISI 316	1x6	120x120	178x790	7.008x31.102	10.68	23.545	
	71 1051 1221	WRFR2 120 2x1 AISI 316	2x1	120x120	346x140	13.622x5.512	4.84	10.679	
	71 1051 1231	WRFR2 120 3x1 AISI 316	3x1	120x120	514x140	20.236x5.512	7.03	15.503	
	71 1051 1811	WRFR2 180 1x1 AISI 316	1x1	180x120	238x140	9.370x5.512	3.23	7.121	
	71 1051 1812	WRFR2 180 1x2 AISI 316	1x2	180x120	238x270	9.370x10.630	5.53	12.181	
	71 1051 1813	WRFR2 180 1x3 AISI 316	1x3	180x120	238x400	9.370x15.748	7.82	17.241	
	71 1051 1814	WRFR2 180 1x4 AISI 316	1x4	180x120	238x530	9.370x20.866	10.12	22.300	
	71 1051 1815	WRFR2 180 1x5 AISI 316	1x5	180x120	238x660	9.370x26.984	12.41	27.359	
	71 1051 1816	WRFR2 180 1x6 AISI 316	1x6	180x120	238x790	9.370x31.102	14.71	32.419	
	71 1051 1821	WRFR2 180 2x1 AISI 316	2x1	180x120	466x140	18.347x5.512	6.00	13.219	
	71 1051 2411	WRFR2 240 1x1 AISI 316	1x1	240x120	298x140	11.732x5.512	3.81	8.400	
	71 1051 2412	WRFR2 240 1x2 AISI 316	1x2	240x120	298x270	11.733x10.630	6.39	14.088	
	71 1051 2413	WRFR2 240 1x3 AISI 316	1x3	240x120	298x400	11.732x15.748	8.97	19.775	
	71 1051 2414	WRFR2 240 1x4 AISI 316	1x4	240x120	298x530	11.732x20.866	11.55	24.581	
	71 1051 2415	WRFR2 240 1x5 AISI 316	1x5	240x120	298x660	11.732x25.984	14.13	31.151	
	71 1051 2416	WRFR2 240 1x6 AISI 316	1x6	240x120	298x790	11.732x31.102	16.71	36.839	

WMR series									
PICTURE DISEGNO	CODE CODICE	ARTICLE ARTICOLO	OPENINGS APERTURE TELAIO	PACKING SPACE SPAZIO DI RIEMPIMENTO	EXTERNAL NOMINAL DIMENSIONS DIMENSIONI ESTERNE NOMINALI HxW (D=60mm)			WEIGHT PESO	
					mm	mm	in	kg	lb
	71 1051 2421	WRFR2 240 2x1 AISI 316	2x1	240x120	586x140	23.07x5.512	7.15	15.759	
	71 1051 2431	WRFR2 240 3x1 AISI 316	3x1	240x120	874x140	34.409x5.512	10.49	23.122	
	71 1052 0611	WRFR2 60 1x1 AL	1x1	60x120	118x140	4.646x5.512	0.70	1.669	
	71 1052 0612	WRFR2 60 1x2 AL	1x2	60x120	118x270	4.646x10.630	1.37	3.020	
	71 1052 0613	WRFR2 60 1x3 AL	1x3	60x120	118x400	4.646x15.748	1.98	4.365	
	71 1052 0614	WRFR2 60 1x4 AL	1x4	60x120	118x530	4.646x20.866	2.59	5.719	
	71 1052 0615	WRFR2 60 1x5 AL	1x5	60x120	118x660	4.646x25.984	3.21	7.070	
	71 1052 0616	WRFR2 60 1x6 AL	1x6	60x120	118x790	4.646x31.102	3.82	8.424	
	71 1052 0621	WRFR2 60 2x1 AL	2x1	60x120	226x140	9.134x5.512	1.25	2.747	
	71 1052 0631	WRFR2 60 3x1 AL	3x1	60x120	334x140	13.504x5.512	1.79	3.946	
	71 1052 1211	WRFR2 120 1x1 AL	1x1	120x120	178x140	7.008x5.512	0.90	1.984	
	71 1052 1212	WRFR2 120 1x2 AL	1x2	120x120	178x270	7.008x10.630	1.58	3.472	
	71 1052 1213	WRFR2 120 1x3 AL	1x3	120x120	178x400	7.008x15.748	2.25	4.960	
	71 1052 1214	WRFR2 120 1x4 AL	1x4	120x120	178x530	7.008x20.866	2.93	6.449	
	71 1052 1215	WRFR2 120 1x5 AL	1x5	120x120	178x660	7.008x25.984	3.60	7.937	
	71 1052 1216	WRFR2 120 1x6 AL	1x6	120x120	178x790	7.008x31.102	4.28	9.425	
	71 1052 1221	WRFR2 120 2x1 AL	2x1	120x120	346x140	13.622x5.512	1.64	3.604	
	71 1052 1222	WRFR2 120 2x2 AL	2x2	120x120	356x270	14.016x10.630	3.35	7.374	
	71 1052 1223	WRFR2 120 2x3 AL	2x3	120x120	356x400	14.016x15.748	4.77	10.505	
	71 1052 1224	WRFR2 120 2x4 AL	2x4	120x120	356x530	14.016x20.866	6.33	13.955	
	71 1052 1231	WRFR2 120 3x1 AL	3x1	120x120	514x140	20.236x5.512	7.90	17.406	
	71 1052 1811	WRFR2 180 1x1 AL	1x1	180x120	238x140	9.370x5.512	1.09	2.403	
	71 1052 1812	WRFR2 180 1x2 AL	1x2	180x120	238x270	9.370x10.630	1.87	4.112	
	71 1052 1813	WRFR2 180 1x3 AL	1x3	180x120	238x400	9.370x15.748	2.64	5.820	
	71 1052 1814	WRFR2 180 1x4 AL	1x4	180x120	238x530	9.370x20.866	3.42	7.529	
	71 1052 1815	WRFR2 180 1x5 AL	1x5	180x120	238x660	9.370x26.984	4.19	9.237	
	71 1052 1816	WRFR2 180 1x6 AL	1x6	180x120	238x790	9.370x31.102	4.97	10.946	
	71 1052 1821	WRFR2 180 2x1 AL	2x1	180x120	466x140	18.347x5.512	2.02	4.462	
	71 1052 1822	WRFR2 180 2x2 AL	2x2	180x120	476x270	18.740x10.630	3.93	8.662	
	71 1052 1823	WRFR2 180 2x3 AL	2x3	180x120	476x400	18.740x15.748	5.54	12.218	
	71 1052 1824	WRFR2 180 2x4 AL	2x4	180x120	476x530	18.740x20.866	7.30	16.096	

WMR series									
PICTURE DISEGNO	CODE CODICE	ARTICLE ARTICOLO	OPENINGS APERTURE TELAIO	PACKING SPACE SPAZIO DI RIEMPIMENTO	EXTERNAL NOMINAL DIMENSIONS DIMENSIONI ESTERNE NOMINALI HxW (D=60mm)			WEIGHT PESO	
					mm	mm	in	kg	lb
	71 1052 1825	WRFR2 180 2x5 AL	2x5	180x120	476x660	18.740x25.984	9.06	19.974	
	71 1052 1826	WRFR2 180 2x6 AL	2x6	180x120	476x790	18.740x31.102	10.82	23.852	
	71 1052 1831	WRFR2 180 3x1 AL	3x1	180x120	694x140	27.323x5.512	5.03	11.078	
	71 1052 2411	WRFR2 240 1x1 AL	1x1	240x120	298x140	11.732x5.512	1.28	2.822	
	71 1052 2412	WRFR2 240 1x2 AL	1x2	240x120	298x270	11.733x10.630	2.16	4.762	
	71 1052 2413	WRFR2 240 1x3 AL	1x3	240x120	298x400	11.732x15.748	3.03	6.680	
	71 1052 2414	WRFR2 240 1x4 AL	1x4	240x120	298x530	11.732x20.866	3.91	8.609	
	71 1052 2415	WRFR2 240 1x5 AL	1x5	240x120	298x660	11.732x25.984	4.78	10.538	
	71 1052 2416	WRFR2 240 1x6 AL	1x6	240x120	298x790	11.732x31.102	5.66	12.467	
	71 1052 2421	WRFR2 240 2x1 AL	2x1	240x120	586x141	23.071x5.512	2.41	5.318	
	71 1052 2431	WRFR2 240 3x1 AL	3x1	240x120	874x141	34.409x5.512	3.54	7.804	

WallMax® Rectangular Frame Rounded

WRFR4 frames are used in combination with WMR series modules and accessories to achieve customized sealing solutions. The numerous combinations of openings and packing space allow for development of cable transit solutions specific to customer's needs.

Cornice Rettangolare Arrotondata WallMax®

Le cornici WRFR4 sono utilizzati in combinazione con i moduli e gli accessori della gamma WMR per offrire soluzioni di sigillatura personalizzate. Sono disponibili varie combinazioni di aperture e dimensioni con le quali si possono ottenere differenti soluzioni di passaggio cavi, a seconda delle specifiche necessità del cliente.



DATASHEET PAGE: 153

MATERIALS	MATERIALI
Primed Steel	Acciaio con prima mano antiruggine
SS AISI 316 L	Acciaio inox resistente agli acidi
Aluminium	Alluminio
Other materials available upon request	Disponibile in altri materiali su richiesta

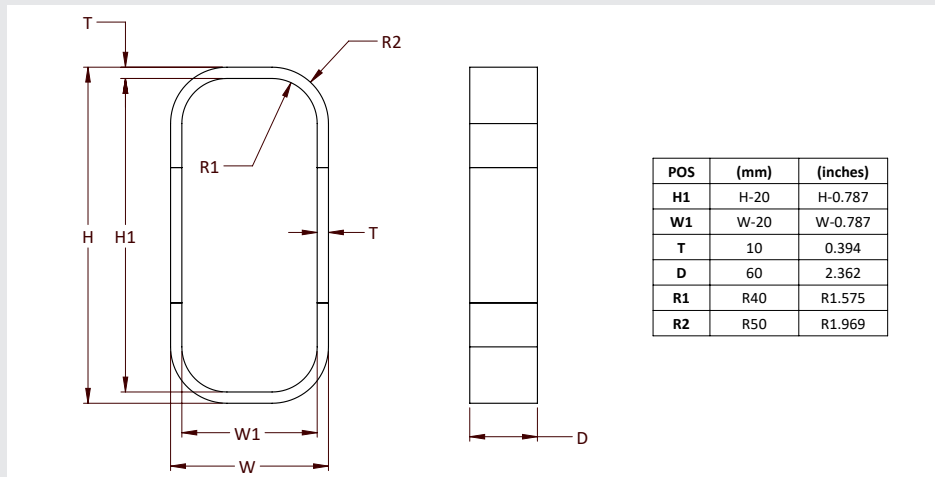























To be used in combination with/utilizzate in combinazione con

WMR series									
PICTURE DISEGNO	CODE CODICE	ARTICLE ARTICOLO	OPENINGS APERTURE TELAIO	PACKING SPACE SPAZIO DI RIEMPIMENTO mm	DIMENSIONI ESTERNE NOMINALI HxW (D=60mm)			WEIGHT PESO	
					mm	in	kg	lb	
	71 1060 1211	WRFR4 120 1x1 Primed	1x1	120x120	178x140	7.008x5.512	2.43	5.353	
	71 1060 1212	WRFR4 120 1x2 Primed	1x2	120x120	178x270	7.008x10.630	4.38	9.656	
	71 1060 1213	WRFR4 120 1x3 Primed	1x3	120x120	178x400	7.008x15.748	6.34	13.977	
	71 1060 1214	WRFR4 120 1x4 Primed	1x4	120x120	178x530	7.008x20.866	8.30	18.290	
	71 1060 1215	WRFR4 120 1x5 Primed	1x5	120x120	178x660	7.008x25.984	10.25	22.602	
	71 1060 1216	WRFR4 120 1x6 Primed	1x6	120x120	178x790	7.008x31.102	12.21	26.914	
	71 1060 1217	WRFR4 120 1x7 Primed	1x7	120x120	178x920	7.008x36.221	14.16	31.226	
	71 1060 1218	WRFR4 120 1x8 Primed	1x8	120x120	178x1050	7.008x41.339	16.12	35.539	
	71 1060 1219	WRFR4 120 1x9 Primed	1x9	120x120	178x1180	7.008x46.457	18.08	39.851	
	71 1060 1221	WRFR4 120 2x1 Primed	2x1	120x120	346x140	13.622x5.512	4.56	10.057	
	71 1060 1222	WRFR4 120 2x2 Primed	2x2	120x120	356x270	14.016x10.630	9.47	20.869	
	71 1060 1223	WRFR4 120 2x3 Primed	2x3	120x120	356x400	14.016x15.748	13.57	29.908	
	71 1060 1224	WRFR4 120 2x4 Primed	2x4	120x120	356x530	14.016x20.866	18.07	39.833	
	71 1060 1225	WRFR4 120 2x5 Primed	2x5	120x120	356x660	14.016x25.984	22.57	49.758	
	71 1060 1226	WRFR4 120 2x6 Primed	2x6	120x120	356x790	14.016x31.102	27.07	59.684	
	71 1060 1227	WRFR4 120 2x7 Primed	2x7	120x120	356x920	14.016x36.221	31.57	69.609	
	71 1060 1228	WRFR4 120 2x8 Primed	2x8	120x120	356x1050	14.016x41.339	36.08	79.543	
	71 1060 1231	WRFR4 120 3x1 Primed	3x1	120x120	514x140	20.236x5.512	6.70	14.762	
	71 1060 1232	WRFR4 120 3x2 Primed	3x2	120x120	534x270	21.220x10.630	14.49	31.952	
	71 1060 1233	WRFR4 120 3x3 Primed	3x3	120x120	534x400	21.220x15.748	20.64	45.508	
	71 1060 1234	WRFR4 120 3x4 Primed	3x4	120x120	534x530	21.220x20.866	27.62	60.881	
	71 1060 1235	WRFR4 120 3x5 Primed	3x5	120x120	534x660	21.220x25.984	34.59	76.254	
	71 1060 1236	WRFR4 120 3x6 Primed	3x6	120x120	534x790	21.220x31.102	41.56	91.626	
	71 1060 1811	WRFR4 180 1x1 Primed	1x1	180x120	238x140	9.370x5.512	2.99	6.592	
	71 1060 1812	WRFR4 180 1x2 Primed	1x2	180x120	238x270	9.370x10.630	5.23	11.530	
	71 1060 1813	WRFR4 180 1x3 Primed	1x3	180x120	238x400	9.370x15.748	7.46	16.446	
	71 1060 1814	WRFR4 180 1x4 Primed	1x4	180x120	238x530	9.370x20.866	9.70	21.374	
	71 1060 1815	WRFR4 180 1x5 Primed	1x5	180x120	238x660	9.370x26.984	11.93	26.301	
	71 1060 1816	WRFR4 180 1x6 Primed	1x6	180x120	238x790	9.370x31.102	14.17	31.228	
	71 1060 1817	WRFR4 180 1x7 Primed	1x7	180x120	238x920	9.370x36.221	16.40	36.156	
	71 1060 1818	WRFR4 180 1x8 Primed	1x8	180x120	238x1050	9.370x41.339	18.64	41.083	

WMR series								
PICTURE DISEGNO	CODE CODICE	ARTICLE ARTICOLO	OPENINGS APERTURE TELAIO	PACKING SPACE SPAZIO DI RIEMPIMENTO	DIMENSIONI ESTERNE NOMINALI HxW (D=60mm)		WEIGHT PESO	
					mm	in	kg	lb
	71 1060 1819	WRFR4 180 1x9 Primed	1x9	180x120	238x1180	9.370x46.457	20.87	46.010
	71 1060 1821	WRFR4 180 2x1 Primed	2x1	180x120	466x140	18.347x5.512	5.69	12.533
	71 1060 1822	WRFR4 180 2x2 Primed	2x2	180x120	476x270	18.740x10.630	11.15	24.584
	71 1060 1823	WRFR4 180 2x3 Primed	2x3	180x120	476x400	18.740x15.748	15.81	34.862
	71 1060 1824	WRFR4 180 2x4 Primed	2x4	180x120	476x530	18.740x20.866	20.88	46.026
	71 1060 1825	WRFR4 180 2x5 Primed	2x5	180x120	476x660	18.740x25.984	25.94	57.190
	71 1060 1826	WRFR4 180 2x6 Primed	2x6	180x120	476x790	18.740x31.102	31.01	68.354
	71 1060 1827	WRFR4 180 2x7 Primed	2x7	180x120	476x920	18.740x36.221	36.07	79.519
	71 1060 1828	WRFR4 180 2x8 Primed	2x8	180x120	476x1050	18.740x41.339	41.13	90.683
	71 1060 1829	WRFR4 180 2x9 Primed	2x9	180x120	476x1180	18.740x46.457	46.20	101.847
	71 1060 1820	WRFR4 180 2x10 Primed	2x10	180x120	476x1310	18.740x51.575	51.26	113.011
	71 1060 1831	WRFR4 180 3x1 Primed	3x1	180x120	694x140	27.323x5.512	8.83	19.469
	71 1060 2411	WRFR4 240 1x1 Primed	1x1	240x120	298x140	11.732x5.512	3.55	7.829
	71 1060 2412	WRFR4 240 1x2 Primed	1x2	240x120	298x270	11.733x10.630	6.07	13.382
	71 1060 2413	WRFR4 240 1x3 Primed	1x3	240x120	298x400	11.732x15.748	8.59	18.938
	71 1060 2414	WRFR4 240 1x4 Primed	1x4	240x120	298x530	11.732x20.866	11.11	24.492
	71 1060 2415	WRFR4 240 1x5 Primed	1x5	240x120	298x660	11.732x25.984	13.63	30.047
	71 1060 2416	WRFR4 240 1x6 Primed	1x6	240x120	298x790	11.732x31.102	16.15	35.601
	71 1060 2421	WRFR4 240 2x1 Primed	2x1	240x120	586x140	23.071x5.512	6.81	15.009
	71 1060 2422	WRFR4 240 2x2 Primed	2x2	240x120	596x270	23.465x10.630	12.84	28.299
	71 1060 2423	WRFR4 240 2x3 Primed	2x3	240x120	596x400	23.465x15.748	18.06	39.813
	71 1060 2424	WRFR4 240 2x4 Primed	2x4	240x120	596x530	23.465x20.866	23.68	52.215
	71 1060 2425	WRFR4 240 2x5 Primed	2x5	240x120	596x660	23.465x25.984	29.31	64.618
	71 1060 2426	WRFR4 240 2x6 Primed	2x6	240x120	596x790	23.465x31.102	34.94	77.020
	71 1060 2427	WRFR4 240 2x7 Primed	2x7	240x120	596x920	23.465x36.221	40.56	89.422
	71 1060 2428	WRFR4 240 2x8 Primed	2x8	240x120	596x1060	23.465x41.339	46.19	101.824
	71 1060 2429	WRFR4 240 2x9 Primed	2x9	240x120	596x1180	23.465x46.457	51.81	114.226
	71 1060 2420	WRFR4 240 2x10 Primed	2x10	240x120	596x1310	23.465x51.575	57.44	126.628
	71 1060 2431	WRFR4 240 3x1 Primed	3x1	240x120	874x140	34.409x5.512	10.07	22.190
	71 1061 1211	WRFR4 120 1x1 AISI 316	1x1	120x120	178x140	7.008x5.512	2.49	5.490
	71 1061 1212	WRFR4 120 1x2 AISI 316	1x2	120x120	178x270	7.008x10.630	4.55	10.040

WMR series								
PICTURE DISEGNO	CODE CODICE	ARTICLE ARTICOLO	OPENINGS APERTURE TELAIO	PACKING SPACE SPAZIO DI RIEMPIMENTO	DIMENSIONI ESTERNE NOMINALI HxW (D=60mm)		WEIGHT PESO	
					mm	in	kg	lb
	71 1061 1213	WRFR4 120 1x3 AISI 316	1x3	120x120	178x400	7.008x15.748	6.66	14.674
	71 1061 1214	WRFR4 120 1x4 AISI 316	1x4	120x120	178x530	7.008x20.866	8.74	19.266
	71 1061 1215	WRFR4 120 1x5 AISI 316	1x5	120x120	178x660	7.008x25.984	10.82	23.858
	71 1061 1216	WRFR4 120 1x6 AISI 316	1x6	120x120	178x790	7.008x31.102	12.91	28.451
	71 1061 1221	WRFR4 120 2x1 AISI 316	2x1	120x120	346x140	13.622x5.512	4.68	10.315
	71 1061 1231	WRFR4 120 3x1 AISI 316	3x1	120x120	514x140	20.236x5.512	6.87	14.674
	71 1061 1811	WRFR4 180 1x1 AISI 316	1x1	180x120	238x140	9.370x5.512	3.07	6.768
	71 1061 1812	WRFR4 180 1x2 AISI 316	1x2	180x120	238x270	9.370x10.630	5.36	11.817
	71 1061 1813	WRFR4 180 1x3 AISI 316	1x3	180x120	238x400	9.370x15.748	9.94	21.914
	71 1061 1814	WRFR4 180 1x4 AISI 316	1x4	180x120	238x530	9.370x20.866	12.23	26.963
	71 1061 1815	WRFR4 180 1x5 AISI 316	1x5	180x120	238x660	9.370x26.984	14.52	32.011
	71 1061 1816	WRFR4 180 1x6 AISI 316	1x6	180x120	238x790	9.370x31.102	16.81	37.060
	71 1061 1821	WRFR4 180 2x1 AISI 316	2x1	180x120	466x140	18.347x5.512	5.83	12.855
	71 1061 2411	WRFR4 240 1x1 AISI 316	1x1	240x120	298x140	11.732x5.512	3.64	8.025
	71 1061 2412	WRFR4 240 1x2 AISI 316	1x2	240x120	298x270	11.733x10.630	6.22	13.713
	71 1061 2413	WRFR4 240 1x3 AISI 316	1x3	240x120	298x400	11.732x15.748	8.81	19.423
	71 1061 2414	WRFR4 240 1x4 AISI 316	1x4	240x120	298x530	11.732x20.866	11.40	25.122
	71 1061 2415	WRFR4 240 1x5 AISI 316	1x5	240x120	298x660	11.732x25.984	13.98	30.821
	71 1061 2416	WRFR4 240 1x6 AISI 316	1x6	240x120	298x790	11.732x31.102	16.57	36.520
	71 1061 2421	WRFR4 240 2x1 AISI 316	2x1	240x120	586x140	23.071x5.512	6.98	15.39
	71 1061 2431	WRFR4 240 3x1 AISI 316	3x1	240x120	874x140	34.409x5.512	10.32	22.76
	71 1062 1211	WRFR4 120 1x1 AL	1x1	120x120	178x140	7.008x5.512	0.84	1.852
	71 1062 1212	WRFR4 120 1x2 AL	1x2	120x120	178x270	7.008x10.630	1.52	3.351
	71 1062 1213	WRFR4 120 1x3 AL	1x3	120x120	178x400	7.008x15.748	2.25	4.960
	71 1062 1214	WRFR4 120 1x4 AL	1x4	120x120	178x530	7.008x20.866	2.93	6.449
	71 1062 1215	WRFR4 120 1x5 AL	1x5	120x120	178x660	7.008x25.984	3.60	7.937
	71 1062 1216	WRFR4 120 1x6 AL	1x6	120x120	178x790	7.008x31.102	4.28	9.425
	71 1062 1221	WRFR4 120 2x1 AL	2x1	120x120	346x140	13.622x5.512	1.58	3.481
	71 1062 1222	WRFR4 120 2x2 AL	2x2	120x120	356x270	14.016x10.630	3.28	7.225
	71 1062 1223	WRFR4 120 2x3 AL	2x3	120x120	356x400	14.016x15.748	4.70	10.353
	71 1062 1224	WRFR4 120 2x4 AL	2x4	120x120	356x530	14.016x20.866	6.25	13.789

WMR series								
PICTURE DISEGNO	CODE CODICE	ARTICLE ARTICOLO	OPENINGS APERTURE TELAIO	PACKING SPACE SPAZIO DI RIEMPIMENTO	DIMENSIONI ESTERNE NOMINALI HxW (D=60mm)		WEIGHT PESO	
					mm	in	kg	lb
	71 1062 1231	WRFR4 120 3x1 AL	3x1	120x120	514x140	20.236x5.512	2.32	5.110
	71 1062 1811	WRFR4 180 1x1 AL	1x1	180x120	238x140	9.370x5.512	1.03	2.271
	71 1062 1812	WRFR4 180 1x2 AL	1x2	180x120	238x270	9.370x10.630	1.81	3.990
	71 1062 1813	WRFR4 180 1x3 AL	1x3	180x120	238x400	9.370x15.748	2.58	5.688
	71 1062 1814	WRFR4 180 1x4 AL	1x4	180x120	238x530	9.370x20.866	3.36	7.397
	71 1062 1815	WRFR4 180 1x5 AL	1x5	180x120	238x660	9.370x26.984	4.13	9.105
	71 1062 1816	WRFR4 180 1x6 AL	1x6	180x120	238x790	9.370x31.102	4.91	10.814
	71 1062 1821	WRFR4 180 2x1 AL	2x1	180x120	466x140	18.347x5.512	1.97	4.339
	71 1062 1822	WRFR4 180 2x2 AL	2x2	180x120	476x270	18.740x10.630	3.86	8.510
	71 1062 1823	WRFR4 180 2x3 AL	2x3	180x120	476x400	18.740x15.748	5.47	12.068
	71 1062 1824	WRFR4 180 2x4 AL	2x4	180x120	476x530	18.740x20.866	7.23	15.933
	71 1062 1825	WRFR4 180 2x5 AL	2x5	180x120	476x660	18.740x25.984	8.98	19.798
	71 1062 1826	WRFR4 180 2x6 AL	2x6	180x120	476x790	18.740x31.102	10.73	23.662
	71 1062 1831	WRFR4 180 3x1 AL	3x1	180x120	694x140	27.323x5.512	2.90	6.396
	71 1062 2411	WRFR4 240 1x1 AL	1x1	240x120	298x140	11.732x5.512	1.23	2.712
	71 1062 2412	WRFR4 240 1x2 AL	1x2	240x120	298x270	11.733x10.630	2.10	4.630
	71 1062 2413	WRFR4 240 1x3 AL	1x3	240x120	298x400	11.732x15.748	2.97	6.548
	71 1062 2414	WRFR4 240 1x4 AL	1x4	240x120	298x530	11.732x20.866	3.84	8.466
	71 1062 2415	WRFR4 240 1x5 AL	1x5	240x120	298x660	11.732x25.984	4.71	10.384
	71 1062 2416	WRFR4 240 1x6 AL	1x6	240x120	298x790	11.732x31.102	5.58	12.302
	71 1062 2421	WRFR4 240 2x1 AL	2x1	240x120	586x141	23.071x5.512	2.36	5.203
	71 1062 2431	WRFR4 240 3x1 AL	3x1	240x120	874x141	34.409x5.512	3.48	7.681



WallMax® Rectangular Frame Rounded

WRFR6 frames are used in combination with WMR series modules and accessories to achieve customized sealing solutions. The numerous combinations of openings and packing space allow for development of cable transit solutions specific to customer's needs.

Cornice Rettangolare Arrotondata WallMax®

Le cornici WRFR6 sono utilizzati in combinazione con i moduli e gli accessori della gamma WMR per offrire soluzioni di sigillatura personalizzate.

Sono disponibili varie combinazioni di aperture e dimensioni con le quali si possono ottenere differenti soluzioni di passaggio cavi, a seconda delle specifiche necessità del cliente.





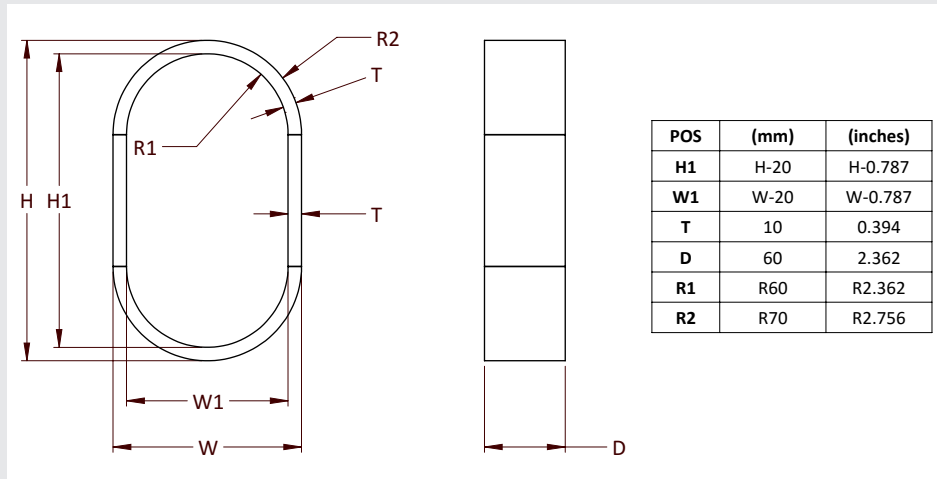







































MATERIALS	MATERIALI
Primed Steel	Acciaio con prima mano antiruggine
SS AISI 316 L	Acciaio inox resistente agli acidi
Aluminium	Alluminio
Other materials available upon request	Disponibile in altri materiali su richiesta



To be used in combination with/utilizzate in combinazione con

WMR series									
PICTURE DISEGNO	CODE CODICE	ARTICLE ARTICOLO	OPENINGS APERTURE TELAIO	PACKING SPACE SPAZIO DI RIEMPIMENTO mm	EXTERNAL NOMINAL DIMENSIONS DIMENSIONI ESTERNE NOMINALI HxW (D=60mm)			WEIGHT PESO	
					mm	in	kg	lb	
	71 1430 1811	WRFR6 180 1x1 Primed	1x1	180x120	238x140	9.370x5.512	2.83	6.237	
	71 1430 1812	WRFR6 180 1x2 Primed	1x2	180x120	238x270	9.370x10.630	5.20	11.131	
	71 1430 1813	WRFR6 180 1x3 Primed	1x3	180x120	238x400	9.370x15.748	7.27	16.025	
	71 1430 1814	WRFR6 180 1x4 Primed	1x4	180x120	238x530	9.370x20.866	9.48	20.920	
	71 1430 1815	WRFR6 180 1x5 Primed	1x5	180x120	238x660	9.370x26.984	11.71	25.814	
	71 1430 1816	WRFR6 180 1x6 Primed	1x6	180x120	238x790	9.370x31.102	13.93	30.708	
	71 1430 1817	WRFR6 180 1x7 Primed	1x7	180x120	238x920	9.370x36.221	16.15	35.602	
	71 1430 1818	WRFR6 180 1x8 Primed	1x8	180x120	238x1050	9.370x41.339	18.37	40.497	
	71 1430 1819	WRFR6 180 1x9 Primed	1x9	180x120	238x1180	9.370x46.457	20.59	45.391	
	71 1430 1821	WRFR6 180 2x1 Primed	2x1	180x120	466x140	18.347x5.512	5.52	12.178	
	71 1430 1822	WRFR6 180 2x2 Primed	2x2	180x120	476x270	18.740x10.630	11.03	24.313	
	71 1430 1823	WRFR6 180 2x3 Primed	2x3	180x120	476x400	18.740x15.748	15.69	34.588	
	71 1430 1824	WRFR6 180 2x4 Primed	2x4	180x120	476x530	18.740x20.866	20.77	45.793	
	71 1430 1825	WRFR6 180 2x5 Primed	2x5	180x120	476x660	18.740x25.984	25.85	56.998	
	71 1430 1826	WRFR6 180 2x6 Primed	2x6	180x120	476x790	18.740x31.102	30.94	68.203	
	71 1430 1827	WRFR6 180 2x7 Primed	2x7	180x120	476x920	18.740x36.221	36.02	79.408	
	71 1430 1828	WRFR6 180 2x8 Primed	2x8	180x120	476x1050	18.740x41.339	41.10	90.613	
	71 1430 1829	WRFR6 180 2x9 Primed	2x9	180x120	476x1180	18.740x46.457	46.18	101.818	
	71 1430 1820	WRFR6 180 2x10 Primed	2x10	180x120	476x1310	18.740x51.575	51.27	113.023	
	71 1430 1831	WRFR6 180 3x1 Primed	3x1	180x120	694x140	27.323x5.512	8.22	18.122	
	71 1430 2411	WRFR6 240 1x1 Primed	1x1	240x120	298x140	11.732x5.512	3.39	7.474	
	71 1430 2412	WRFR6 240 1x2 Primed	1x2	240x120	298x270	11.733x10.630	5.91	13.027	
	71 1430 2413	WRFR6 240 1x3 Primed	1x3	240x120	298x400	11.732x15.748	8.43	18.581	
	71 1430 2414	WRFR6 240 1x4 Primed	1x4	240x120	298x530	11.732x20.866	10.95	24.134	
	71 1430 2415	WRFR6 240 1x5 Primed	1x5	240x120	298x660	11.732x25.984	13.45	29.643	
	71 1430 2416	WRFR6 240 1x6 Primed	1x6	240x120	298x790	11.732x31.102	15.99	35.241	
	71 1430 2421	WRFR6 240 2x1 Primed	2x1	240x120	586x140	23.071x5.512	6.65	14.656	
	71 1430 2422	WRFR6 240 2x2 Primed	2x2	240x120	596x270	23.465x10.630	12.71	28.027	
	71 1430 2423	WRFR6 240 2x3 Primed	2x3	240x120	596x400	23.465x15.748	17.94	39.542	
	71 1430 2424	WRFR6 240 2x4 Primed	2x4	240x120	596x530	23.465x20.866	23.58	51.985	

WMR series									
PICTURE DISEGNO	CODE CODICE	ARTICLE ARTICOLO	OPENINGS APERTURE TELAIO	PACKING SPACE SPAZIO DI RIEMPIMENTO	EXTERNAL NOMINAL DIMENSIONS DIMENSIONI ESTERNE NOMINALI HxW (D=60mm)			WEIGHT PESO	
					mm	mm	in	kg	lb
	71 1430 2425	WRFR6 240 2x5 Primed	2x5	240x120	596x660	23.465x25.984	29.22	64.428	
	71 1430 2426	WRFR6 240 2x6 Primed	2x6	240x120	596x790	23.465x31.102	34.87	76.871	
	71 1430 2427	WRFR6 240 2x7 Primed	2x7	240x120	596x920	23.465x36.221	40.51	89.314	
	71 1430 2428	WRFR6 240 2x8 Primed	2x8	240x120	596x1430	23.465x41.339	46.16	101.757	
	71 1430 2429	WRFR6 240 2x9 Primed	2x9	240x120	596x1180	23.465x46.457	51.80	111.200	
	71 1430 2420	WRFR6 240 2x10 Primed	2x10	240x120	596x1310	23.465x51.575	57.44	126.642	
	71 1430 2431	WRFR6 240 3x1 Primed	3x1	240x120	874x140	34.409x5.512	9.91	21.837	
	71 1431 1811	WRFR6 180 1x1 AISI 316	1x1	180x120	238x140	9.370x5.512	2.90	6.396	
	71 1431 1812	WRFR6 180 1x2 AISI 316	1x2	180x120	238x270	9.370x10.630	5.19	11.444	
	71 1431 1813	WRFR6 180 1x3 AISI 316	1x3	180x120	238x400	9.370x15.748	7.48	16.493	
	71 1431 1814	WRFR6 180 1x4 AISI 316	1x4	180x120	238x530	9.370x20.866	9.77	21.541	
	71 1431 1815	WRFR6 180 1x5 AISI 316	1x5	180x120	238x660	9.370x26.984	12.06	26.590	
	71 1431 1816	WRFR6 180 1x6 AISI 316	1x6	180x120	238x790	9.370x31.102	14.35	31.639	
	71 1431 1821	WRFR6 180 2x1 AISI 316	2x1	180x120	466x140	18.347x5.512	5.67	12.491	
	71 1431 2411	WRFR6 240 1x1 AISI 316	1x1	240x120	298x140	11.732x5.512	3.48	7.665	
	71 1431 2412	WRFR6 240 1x2 AISI 316	1x2	240x120	298x270	11.733x10.630	6.06	13.353	
	71 1431 2413	WRFR6 240 1x3 AISI 316	1x3	240x120	298x400	11.732x15.748	8.64	19.041	
	71 1431 2414	WRFR6 240 1x4 AISI 316	1x4	240x120	298x530	11.732x20.866	11.22	24.729	
	71 1431 2415	WRFR6 240 1x5 AISI 316	1x5	240x120	298x660	11.732x25.984	13.80	30.417	
	71 1431 2416	WRFR6 240 1x6 AISI 316	1x6	240x120	298x790	11.732x31.102	16.38	36.105	
	71 1431 2421	WRFR6 240 2x1 AISI 316	2x1	240x120	586x140	23.071x5.512	6.82	15.031	
	71 1431 2431	WRFR6 240 3x1 AISI 316	3x1	240x120	874x140	34.409x5.512	10.16	22.397	
	71 1432 1811	WRFR6 180 1x1 AL	1x1	180x120	238x140	9.370x5.512	0.98	2.158	
	71 1432 1812	WRFR6 180 1x2 AL	1x2	180x120	238x270	9.370x10.630	1.76	3.878	
	71 1432 1813	WRFR6 180 1x3 AL	1x3	180x120	238x400	9.370x15.748	2.54	5.598	
	71 1432 1814	WRFR6 180 1x4 AL	1x4	180x120	238x530	9.370x20.866	3.32	7.317	
	71 1432 1815	WRFR6 180 1x5 AL	1x5	180x120	238x660	9.370x26.984	4.10	9.037	
	71 1432 1816	WRFR6 180 1x6 AL	1x6	180x120	238x790	9.370x31.102	4.88	10.756	
	71 1432 1821	WRFR6 180 2x1 AL	2x1	180x120	466x140	18.347x5.512	1.91	4.215	
	71 1432 1822	WRFR6 180 2x2 AL	2x2	180x120	476x270	18.740x10.630	3.82	8.415	

WMR series									
PICTURE DISEGNO	CODE CODICE	ARTICLE ARTICOLO	OPENINGS APERTURE TELAIO	PACKING SPACE SPAZIO DI RIEMPIMENTO	EXTERNAL NOMINAL DIMENSIONS DIMENSIONI ESTERNE NOMINALI HxW (D=60mm)			WEIGHT PESO	
					mm	mm	in	kg	lb
	71 1432 1823	WRFR6 180 2x3 AL	2x3	180x120	476x400	18.740x15.748	5.43	11.973	
	71 1432 1824	WRFR6 180 2x4 AL	2x4	180x120	476x530	18.740x20.866	7.19	15.852	
	71 1432 1825	WRFR6 180 2x5 AL	2x5	180x120	476x660	18.740x25.984	8.95	19.731	
	71 1432 1826	WRFR6 180 2x6 AL	2x6	180x120	476x790	18.740x31.102	10.71	23.610	
	71 1432 1831	WRFR6 180 3x1 AL	3x1	180x120	694x140	27.323x5.512	2.85	6.272	
	71 1432 2411	WRFR6 240 1x1 AL	1x1	240x120	298x140	11.732x5.512	1.17	2.588	
	71 1432 2412	WRFR6 240 1x2 AL	1x2	240x120	298x270	11.733x10.630	2.04	4.506	
	71 1432 2413	WRFR6 240 1x3 AL	1x3	240x120	298x400	11.732x15.748	2.91	6.424	
	71 1432 2414	WRFR6 240 1x4 AL	1x4	240x120	298x530	11.732x20.866	3.78	8.342	
	71 1432 2415	WRFR6 240 1x5 AL	1x5	240x120	298x660	11.732x25.984	4.65	10.260	
	71 1432 2416	WRFR6 240 1x6 AL	1x6	240x120	298x790	11.732x31.102	5.52	12.178	
	71 1432 2421	WRFR6 240 2x1 AL	2x1	240x120	586x141	23.071x5.512	2.30	5.073	
	71 1432 2431	WRFR6 240 3x1 AL	3x1	240x120	874x141	34.409x5.512	3.43	7.560	

WRFF

WallMax® Rectangular Flanged Frame

WallMax® Rectangular Flanged Frame

WallMax® Rectangular Flanged Frames are metal structures with a 10mm thick flange, and single or multiple openings. Several combinations of sizes and materials are made available, and customized solutions for cable passages can be developed according to customers' needs. WRFF are designed for installation through casting in the wall or welding.

Cornice Rettangolare con Flangia WallMax®

Le Cornici Rettangolari con Flangia sono telai in metallo con flangia di spessore 10mm, disponibili con apertura singola o multipla.

I telai WRFF sono disponibili in un'ampia gamma di dimensioni e materiali. Soluzioni personalizzate possono inoltre essere sviluppate secondo le necessità del cliente.

Le cornici WRFF sono soluzioni di montaggio destinate all'installazione attraverso muratura o saldatura.



WallMax® Rectangular Flanged Frame

WRFF frames are used in combination with WMR series and accessories to create personalized cable transit solutions. Different combinations of modules can be accommodated, according to customer needs.

Cornice Rettangolare con Flangia WallMax®

L'applicazione delle cornici WRFF si completa con l'utilizzo di moduli e accessori della gamma WMR, che permette di ottenere soluzioni personalizzate per il passaggio dei cavi. Sono disponibili differenti combinazioni di sigillatura, secondo le esigenze del cliente.



MATERIALS	MATERIALI
Primed Steel	Acciaio con prima mano antiruggine
SS AISI 316 L	Acciaio inox resistente agli acidi
Aluminium	Alluminio
Other materials available upon request	Disponibile in altri materiali su richiesta

DATASHEET PAGE: 154

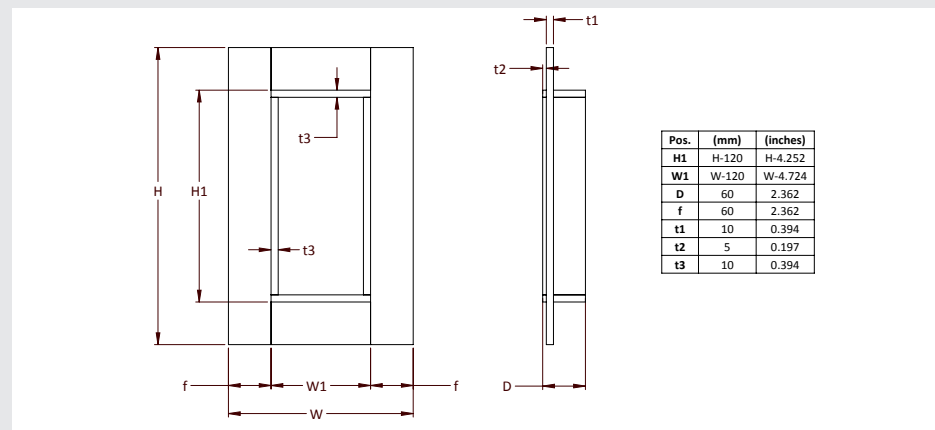

To be used in combination with/utilizzate in combinazione con

WMR series									
PICTURE DISEGNO	CODE CODICE	ARTICLE ARTICOLO	OPENINGS APERTURE TELAIO	PACKING SPACE SPAZIO DI RIEMPIMENTO mm	EXTERNAL NOMINAL DIMENSIONS DIMENSIONI ESTERNE NOMINALI HxW (D=60mm) mm	in	WEIGHT PESO		
							kg	lb	
	71 1010 0611	WRFF 60 1x1 Primed	1x1	60x120	238x260	9.370x10.236	5.77	12.712	
	71 1010 0612	WRFF 60 1x2 Primed	1x2	60x120	238x390	9.370x15.354	8.85	19.450	
	71 1010 0613	WRFF 60 1x3 Primed	1x3	60x120	238x520	9.370x20.472	11.93	26.290	
	71 1010 0614	WRFF 60 1x4 Primed	1x4	60x120	238x650	9.370x25.591	15.00	33.079	
	71 1010 0615	WRFF 60 1x5 Primed	1x5	60x120	238x780	9.370x30.709	18.08	39.868	
	71 1010 0616	WRFF 60 1x6 Primed	1x6	60x120	238x910	9.370x35.827	21.16	46.658	
	71 1010 1211	WRFF 120 1x1 Primed	1x1	120x120	298x260	11.732x10.236	6.89	15.188	
	71 1010 1212	WRFF 120 1x2 Primed	1x2	120x120	298x390	11.732x15.354	10.25	22.595	
	71 1010 1213	WRFF 120 1x3 Primed	1x3	120x120	298x520	11.732x20.472	13.61	30.003	
	71 1010 1214	WRFF 120 1x4 Primed	1x4	120x120	298x650	11.732x25.591	16.97	37.410	
	71 1010 1215	WRFF 120 1x5 Primed	1x5	120x120	298x780	11.732x30.709	20.33	44.818	
	71 1010 1216	WRFF 120 1x6 Primed	1x6	120x120	298x910	11.732x35.827	23.69	52.225	
	71 1010 1221	WRFF 120 2x1 Primed	2x1	120x120	466x260	18.347x10.236	10.60	23.360	
	71 1010 1231	WRFF 120 3x1 Primed	3x1	120x120	630x260	24.803x10.236	14.96	32.975	
	71 1010 1811	WRFF 180 1x1 Primed	1x1	180x120	358x260	14.095x10.236	8.01	17.663	
	71 1010 1812	WRFF 180 1x2 Primed	1x2	180x120	358x390	14.095x15.354	11.65	25.693	
	71 1010 1813	WRFF 180 1x3 Primed	1x3	180x120	358x520	14.095x20.472	15.29	33.717	
	71 1010 1814	WRFF 180 1x4 Primed	1x4	180x120	358x650	14.095x25.591	18.94	41.745	
	71 1010 1815	WRFF 180 1x5 Primed	1x5	180x120	358x780	14.095x30.709	22.58	49.772	
	71 1010 1816	WRFF 180 1x6 Primed	1x6	180x120	358x910	14.095x35.827	26.22	57.799	
	71 1010 1821	WRFF 180 2x1 Primed	2x1	180x120	586x260	23.071x10.236	12.84	28.312	
	71 1010 1822	WRFF 180 2x2 Primed	2x2	180x120	596x390	23.465x15.354	19.56	43.127	
	71 1010 1823	WRFF 180 2x3 Primed	2x3	180x120	596x520	23.465x20.472	25.53	56.293	
	71 1010 1824	WRFF 180 2x4 Primed	2x4	180x120	596x650	23.465x25.591	31.88	70.283	
	71 1010 1825	WRFF 180 2x5 Primed	2x5	180x120	596x780	23.465x30.709	38.23	84.274	
	71 1010 1826	WRFF 180 2x6 Primed	2x6	180x120	596x910	23.465x35.827	44.57	98.264	
	71 1010 1827	WRFF 180 2x7 Primed	2x7	180x120	596x1040	23.465x40.945	50.92	112.255	
	71 1010 1828	WRFF 180 2x8 Primed	2x8	180x120	596x1170	23.465x46.063	57.26	126.246	
	71 1010 1829	WRFF 180 2x9 Primed	2x9	180x120	596x1300	23.465x51.181	63.61	140.236	
	71 1010 1820	WRFF 180 2x10 Primed	2x10	180x120	596x1430	23.465x56.299	69.96	154.227	

WMR series									
PICTURE DISEGNO	CODE CODICE	ARTICLE ARTICOLO	OPENINGS APERTURE TELAIO	PACKING SPACE SPAZIO DI RIEMPIMENTO	EXTERNAL NOMINAL DIMENSIONS DIMENSIONI ESTERNE NOMINALI HxW (D=60mm)			WEIGHT PESO	
					mm	mm	in	kg	lb
	71 1010 1831	WRFF 180 3x1 Primed	3x1	180x120	814x260	32.047x10.236	16.48	36.332	
	71 1010 2411	WRFF 240 1X1 Primed	1x1	240x120	418x260	16.457x15.354	9.14	20.139	
	71 1010 2412	WRFF 240 1X2 Primed	1x2	240x120	418x390	16.457x20.472	13.06	28.786	
	71 1010 2413	WRFF 240 1X3 Primed	1x3	240x120	418x520	16.457x25.591	16.98	37.432	
	71 1010 2414	WRFF 240 1X4 Primed	1x4	240x120	418x650	16.457x30.709	20.90	46.079	
	71 1010 2415	WRFF 240 1X5 Primed	1x5	240x120	418x780	16.457x35.827	24.82	54.725	
	71 1010 2416	WRFF 240 1X6 Primed	1x6	240x120	418x910	16.457x35.827	28.75	63.732	
	71 1010 2421	WRFF 240 2X1 Primed	2x1	240x120	706x260	27.795x10.236	15.09	33.263	
	71 1010 2422	WRFF 240 2X2 Primed	2x2	240x120	716x390	28.189x20.472	22.37	49.317	
	71 1010 2423	WRFF 240 2X3 Primed	2x3	240x120	716x520	28.189x25.591	28.90	63.722	
	71 1010 2424	WRFF 240 2X4 Primed	2x4	240x120	716x650	28.189x30.709	35.81	78.952	
	71 1010 2425	WRFF 240 2X5 Primed	2x5	240x120	716x780	28.189x30.709	42.72	94.181	
	71 1010 2426	WRFF 240 2X6 Primed	2x6	240x120	716x910	28.189x35.827	49.63	109.411	
	71 1010 2427	WRFF 240 2X7 Primed	2x7	240x120	716x1040	28.189x40.945	56.54	124.651	
	71 1010 2428	WRFF 240 2X8 Primed	2x8	240x120	716x1170	28.189x46.063	63.44	139.870	
	71 1010 2429	WRFF 240 2X9 Primed	2x9	240x120	716x1300	28.189x51.181	70.35	155.100	
	71 1010 2420	WRFF 240 2X10 Primed	2x10	240x120	716x1430	28.189x56.299	77.26	170.329	
	71 1010 2431	WRFF 240 3X1 Primed	3x1	240x120	994x260	39.134x10.236	21.70	47.831	
	71 1011 0611	WRFF 60 1x1 AISI 316	1x1	60x120	238x260	9.370x10.236	5.91	13.038	
	71 1011 1211	WRFF 120 1x1 AISI 316	1x1	120x120	298x260	11.732x10.236	7.07	15.578	
	71 1011 1212	WRFF 120 1x2 AISI 316	1x2	120x120	298x390	11.732x20.472	10.51	23.175	
	71 1011 1213	WRFF 120 1x3 AISI 316	1x3	120x120	298x520	11.732x25.591	13.96	30.772	
	71 1011 1214	WRFF 120 1x4 AISI 316	1x4	120x120	298x650	11.732x30.709	17.40	38.369	
	71 1011 1811	WRFF 180 1x1 AISI 316	1x1	180x120	358x260	14.095x10.236	8.22	18.118	
	71 1011 1812	WRFF 180 1x2 AISI 316	1x2	180x120	358x390	14.095x20.472	11.95	26.350	
	71 1011 1813	WRFF 180 1x3 AISI 316	1x3	180x120	358x520	14.095x25.591	15.69	34.582	
	71 1011 1814	WRFF 180 1x4 AISI 316	1x4	180x120	358x650	14.095x30.709	19.42	42.814	
	71 1011 2411	WRFF 240 1X1 AISI 316	1x1	240x120	418x260	16.457x10.236	9.37	20.657	
	71 1011 2412	WRFF 240 1X2 AISI 316	1x2	240x120	418x390	16.457x20.472	13.39	29.524	
	71 1011 2413	WRFF 240 1X3 AISI 316	1x3	240x120	418x520	16.457x25.591	17.41	38.391	
	71 1011 2414	WRFF 240 1X4 AISI 316	1x4	240x120	418x650	16.457x30.709	21.44	47.258	

WMR series									
PICTURE DISEGNO	CODE CODICE	ARTICLE ARTICOLO	OPENINGS APERTURE TELAIO	PACKING SPACE SPAZIO DI RIEMPIMENTO	EXTERNAL NOMINAL DIMENSIONS DIMENSIONI ESTERNE NOMINALI HxW (D=60mm)			WEIGHT PESO	
					mm	mm	in	kg	lb
	71 1012 0621	WRFF 60 2X1 AL	2x1	60x120	346x260	13.662x10.236	2.89	6.371	
	71 1012 1211	WRFF 120 1X1 AL	1x1	120x120	300x260	11.811x10.236	2.39	5.258	
	71 1012 1212	WRFF 120 1X2 AL	1x2	120x120	300x390	11.811x15.354	3.55	7.822	
	71 1012 1213	WRFF 120 1X3 AL	1x3	120x120	300x520	11.811x20.472	4.71	11.386	
	71 1012 1214	WRFF 120 1X4 AL	1x4	120x120	300x650	11.811x25.590	5.87	12.950	
	71 1012 1811	WRFF 180 1X1 AL	1x1	180x120	358x260	14.095x10.236	2.77	6.113	
	71 1012 1812	WRFF 180 1X2 AL	1x2	180x120	358x390	14.095x15.354	4.03	8.893	
	71 1012 1813	WRFF 180 1X3 AL	1x3	180x120	358x520	14.095x20.472	5.29	11.671	
	71 1012 1814	WRFF 180 1X4 AL	1x4	180x120	358x650	14.095x25.590	6.56	14.450	
	71 1012 2411	WRFF 240 1X1 AL	1x1	240x120	418x260	16.457x10.236	3.16	6.971	
	71 1012 2412	WRFF 240 1X2 AL	1x2	240x120	418x390	16.457x15.354	4.52	9.965	
	71 1012 2413	WRFF 240 1X3 AL	1x3	240x120	418x520	16.457x20.472	5.88	12.957	
	71 1012 2414	WRFF 240 1X4 AL	1x4	240x120	418x650	16.457x25.590	7.24	15.950	

WRFFO

WallMax® Rectangular Flanged Frame Openable

WallMax® Rectangular Flanged Frame Openable

WallMax® Rectangular Flanged Frames Openable are metal structures with a 10mm thick flange, and single wall opening. Several combinations of sizes and materials are made available, and customized solutions for cable passages can be developed according to customers' needs. WRFFO solutions are designed for installation where cables/pipes are already in place and it is not feasible to cut them and re-installed them. They are supplied with a partially welded side. WRFFO are designed for installation through casting in the wall or welding.

Cornice Rettangolare con Flangia Scomponibile WallMax®

Le Cornici Rettangolari con Flangia Scomponibile sono telai in metallo con flangia di spessore 10mm, disponibili con apertura singola. I telai WRFFO sono disponibili in un'ampia gamma di dimensioni e materiali. Soluzioni personalizzate possono inoltre essere sviluppate secondo le necessità del cliente. I telai WRFFO sono pensati per soluzioni di installazione dove sono già presenti dei cavi o tubi e il cliente vuole evitare di tagliarli e di conseguenza rigiuntarli. Vengono forniti con un lato non completamente saldato. Le cornici WRFFO sono soluzioni di montaggio destinate all'installazione attraverso muratura o saldatura.





WallMax® Rectangular Flanged Frame Openable

WRFFO frames are used in combination with WMR series and accessories to create personalized cable transit solutions. Different combinations of modules can be accommodated, according to customer's needs.

Cornice Rettangolare con Flangia Scomponibile WallMax®

L'applicazione delle cornici WRFFO si completa con l'utilizzo di moduli e accessori della gamma WMR, che permette di ottenere soluzioni personalizzate per il passaggio dei cavi. Sono disponibili differenti combinazioni di sigillatura, secondo le esigenze del cliente.

MATERIALS	MATERIALI
Primed Steel	Acciaio con prima mano antiruggine
SS AISI 316 L	Acciaio inox resistente agli acidi
Aluminium	Alluminio
Other materials available upon request	Disponibile in altri materiali su richiesta

DATASHEET PAGE: 155

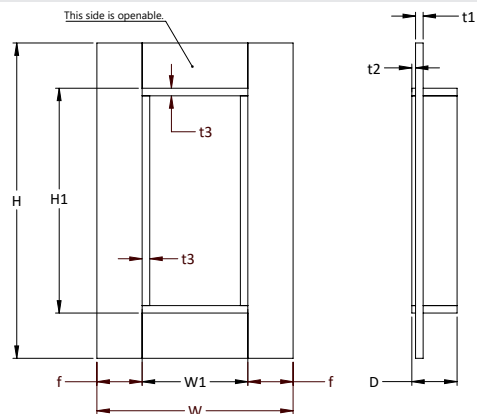

Pos.	(mm)	(inches)
H1	H-120	H-4.252
W1	W-120	W-4.724
D	60	2.362
f	60	2.362
t1	10	0.394
t2	5	0.197
t3	10	0.394

To be used in combination with/utilizzate in combinazione con

WMR series									
PICTURE DISEGNO	CODE CODICE	ARTICLE ARTICOLO	OPENINGS APERTURE TELAIO	PACKING SPACE SPAZIO DI RIEMPIMENTO	EXTERNAL NOMINAL DIMENSIONS			WEIGHT	
					mm	mm	in	kg	lb
	71 1260 0611	WRFFO 60 1x1 Primed	1x1	60x120	238x260	9.370x10.236	5.67	12.491	
	71 1260 1211	WRFFO 120 1x1 Primed	1x1	120x120	298x260	11.732x10.236	6.79	14.961	
	71 1260 1811	WRFFO 180 1x1 Primed	1x1	180x120	358x260	14.095x10.236	7.91	17.429	
	71 1260 2411	WRFFO 240 1x1 Primed	1x1	240x120	418x260	16.457x10.236	9.04	19.921	
	71 1261 0611	WRFFO 60 1x1 AISI 316	1x1	60x120	238x260	9.370x10.236	5.75	12.666	
	71 1261 1211	WRFFO 120 1x1 AISI 316	1x1	120x120	298x260	11.732x10.236	6.94	15.291	
	71 1261 1811	WRFFO 180 1x1 AISI 316	1x1	180x120	358x260	14.095x10.236	8.10	17.849	
	71 1261 2411	WRFFO 240 1x1 AISI 316	1x1	240x120	418x260	16.457x10.236	9.27	20.430	
	71 1262 0611	WRFFO 60 1x1 AL	1x1	60x120	238x260	9.370x10.236	1.96	4.323	
	71 1262 1211	WRFFO 120 1x1 AL	1x1	120x120	298x260	11.732x10.236	2.33	5.157	
	71 1262 1811	WRFFO 180 1x1 AL	1x1	180x120	358x260	14.095x10.236	2.72	5.994	
	71 1262 2411	WRFFO 240 1x1 AL	1x1	240x120	418x260	16.457x10.236	3.13	6.896	

WRFFL

WallMax® Rectangular Flanged Frame Light

WallMax® Rectangular Flanged Frame Light

WallMax® Rectangular Flanged Frames Light are structures with a 6mm thick flange and one or more openings.

A large variety of pre-designed, single and multiple opening combinations is offered, and additional customized solutions in terms of packing space and materials can be developed to accommodate specific customer's needs.

WRFFL are designed for installation through casting in the wall or welding.

Cornice Rettangolare Leggera con Flangia WallMax®

Le Cornici Rettangolari Leggere con Flangia sono telai con flangia di spessore 6mm, disponibili con apertura singola o multipla.

WallMax® dispone di un'ampia gamma di soluzioni ad apertura singola o multipla e, in aggiunta, offre al cliente la possibilità di personalizzare le cornici, sia per quanto riguarda le aperture che per quanto riguarda la scelta dei materiali.

Le cornici WRFFL sono soluzioni di montaggio destinate all'installazione attraverso muratura o saldatura.



Cornice Rettangolare Leggera con Flangia WallMax®

Sealing solutions using WRFFL frames are used with a combination of WMR series modules and accessories selected according to customer-specific needs.

WallMax® Rectangular Flanged Frame Light

Le soluzioni di sigillatura con cornice WRFFL sono pensate per l'utilizzo con i moduli e gli accessori della gamma WMR. Questi ultimi possono essere abbinati a piacimento per ottenere combinazioni di passaggio cavi completamente personalizzate.

MATERIALS	MATERIALI
SS AISI 316 L	Acciaio inox resistente agli acidi
Primed Steel	Acciaio con prima mano antiruggine
Galvanized Steel	Acciaio galvanizzato
Other materials available upon request	Disponibile in altri materiali su richiesta





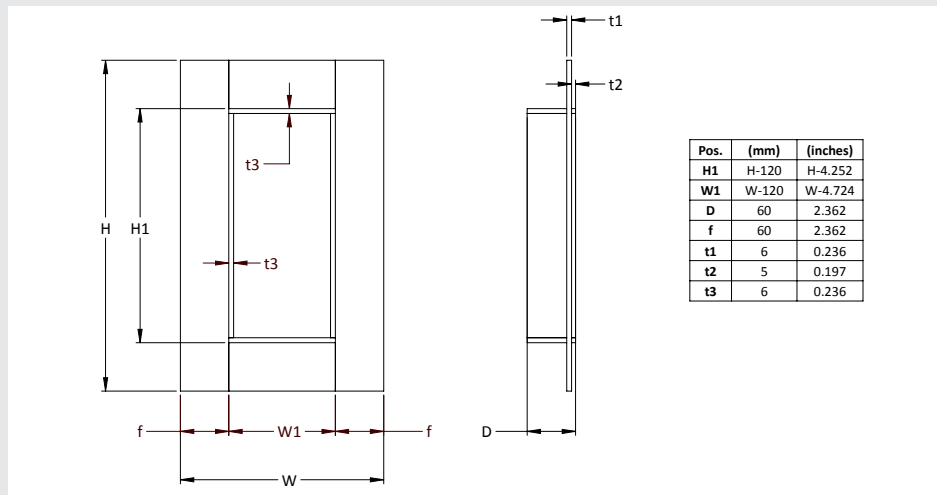











































DATASHEET PAGE: 156



To be used in combination with/utilizzate in combinazione con

WMR series									
PICTURE DISEGNO	CODE CODICE	ARTICLE ARTICOLO	OPENINGS APERTURE TELAIO	PACKING SPACE SPAZIO DI RIEMPIMENTO mm	EXTERNAL NOMINAL DIMENSIONS DIMENSIONI ESTERNE NOMINALI HxW (D=60mm)			WEIGHT PESO	
					mm	mm	in	kg	lb
	71 1040 0611	WRFFL 60 - 1x1 Primed	1x1	60x120	230x252	9.055x9.921	3.33	7.330	
	71 1040 0612	WRFFL 60 - 1x2 Primed	1x2	60x120	230x382	9.055x15.039	5.23	11.521	
	71 1040 0613	WRFFL 60 - 1x3 Primed	1x3	60x120	230x512	9.055x20.158	7.21	15.887	
	71 1040 0614	WRFFL 60 - 1x4 Primed	1x4	60x120	230x642	9.055x25.276	9.15	20.165	
	71 1040 1211	WRFFL 120 - 1x1 Primed	1x1	120x120	290x252	11.417x9.921	4.00	8.816	
	71 1040 1212	WRFFL 120 - 1x2 Primed	1x2	120x120	290x382	11.417x15.039	6.22	13.715	
	71 1040 1213	WRFFL 120 - 1x3 Primed	1x3	120x120	290x512	11.417x20.178	8.44	18.614	
	71 1040 1214	WRFFL 120 - 1x4 Primed	1x4	120x120	290x642	11.417x25.276	10.67	23.512	
	71 1040 1215	WRFFL 120 - 1x5 Primed	1x5	120x120	290x772	11.417x30.394	12.89	28.411	
	71 1040 1216	WRFFL 120 - 1x6 Primed	1x6	120x120	290x902	11.417x35.512	15.11	33.310	
	71 1040 1221	WRFFL 120 - 2x1 Primed	2x1	120x120	458x252	18.032x9.921	6.45	14.213	
	71 1040 1222	WRFFL 120 - 2x2 Primed	2x2	120x120	460x382	18.110x15.039	10.29	22.675	
	71 1040 1223	WRFFL 120 - 2x3 Primed	2x3	120x120	460x512	18.110x20.158	13.99	30.838	
	71 1040 1224	WRFFL 120 - 2x4 Primed	2x4	120x120	460x642	18.110x25.276	17.76	39.152	
	71 1040 1225	WRFFL 120 - 2x5 Primed	2x5	120x120	460x772	18.110x30.394	21.53	47.463	
	71 1040 1226	WRFFL 120 - 2x6 Primed	2x6	120x120	460x902	18.110x35.512	25.30	55.777	
	71 1040 1227	WRFFL 120 - 2x7 Primed	2x7	120x120	460x1032	18.110x40.630	29.07	64.088	
	71 1040 1228	WRFFL 120 - 2x8 Primed	2x8	120x120	460x1162	18.110x45.748	32.84	72.402	
	71 1040 1229	WRFFL 120 - 2x9 Primed	2x9	120x120	460x1292	18.110x50.866	36.61	80.713	
	71 1040 1220	WRFFL 120 - 2x10 Primed	2x10	120x120	460x1422	18.110x55.984	40.38	89.027	
	71 1040 1231	WRFFL 120 - 3x1 Primed	3x1	120x120	626x252	24.646x9.921	8.90	19.612	
	71 1040 1811	WRFFL 180 - 1x1 Primed	1x1	180x120	350x252	13.780x9.921	4.67	10.302	
	71 1040 1812	WRFFL 180 - 1x2 Primed	1x2	180x120	350x382	13.780x15.039	7.18	15.818	
	71 1040 1813	WRFFL 180 - 1x3 Primed	1x3	180x120	350x512	13.780x20.158	9.68	21.336	
	71 1040 1814	WRFFL 180 - 1x4 Primed	1x4	180x120	350x642	13.780x25.276	12.18	26.857	
	71 1040 1815	WRFFL 180 - 1x5 Primed	1x5	180x120	350x772	13.780x30.394	14.68	32.370	
	71 1040 1816	WRFFL 180 - 1x6 Primed	1x6	180x120	350x902	13.780x35.512	17.19	37.888	
	71 1040 1821	WRFFL 180 - 2x1 Primed	2x1	180x120	578x252	22.756x9.921	7.80	17.185	
	71 1040 1822	WRFFL 180 - 2x2 Primed	2x2	180x120	580x382	22.835x15.039	12.19	26.883	

WMR series									
PICTURE DISEGNO	CODE CODICE	ARTICLE ARTICOLO	OPENINGS APERTURE TELAIO	PACKING SPACE SPAZIO DI RIEMPIMENTO	EXTERNAL NOMINAL DIMENSIONS DIMENSIONI ESTERNE NOMINALI HxW (D=60mm)			WEIGHT PESO	
					mm	mm	in	kg	lb
	71 1040 1823	WRFFL 180 - 2x3 Primed	2x3	180x120	580x512	22.835x20.158	16.46	36.286	
	71 1040 1824	WRFFL 180 - 2x4 Primed	2x4	180x120	580x642	22.835x25.276	20.79	45.836	
	71 1040 1825	WRFFL 180 - 2x5 Primed	2x5	180x120	580x772	22.835x30.394	25.12	55.387	
	71 1040 1826	WRFFL 180 - 2x6 Primed	2x6	180x120	580x902	22.835x35.512	29.46	64.937	
	71 1040 1827	WRFFL 180 - 2x7 Primed	2x7	180x120	580x1032	22.835x40.630	33.79	74.488	
	71 1040 1828	WRFFL 180 - 2x8 Primed	2x8	180x120	580x1162	22.835x45.748	38.12	84.038	
	71 1040 1829	WRFFL 180 - 2x9 Primed	2x9	180x120	580x1292	22.835x50.866	42.45	93.588	
	71 1040 1820	WRFFL 180 - 2x10 Primed	2x10	180x120	580x1422	22.835x55.984	46.78	103.139	
	71 1040 1831	WRFFL 180 - 3x1 Primed	3x1	180x120	806x252	31.732x9.921	10.92	24.070	
	71 1040 2411	WRFFL 240 - 1x1 Primed	1x1	240x120	410x252	16.142x9.921	5.35	11.756	
	71 1040 2412	WRFFL 240 - 1x2 Primed	1x2	240x120	410x382	16.142x15.039	8.13	17.924	
	71 1040 2413	WRFFL 240 - 1x3 Primed	1x3	240x120	410x512	16.142x20.158	10.91	24.061	
	71 1040 2414	WRFFL 240 - 1x4 Primed	1x4	240x120	410x642	16.142x25.276	13.70	30.199	
	71 1041 0611	WRFFL 60 1x1 AISI 316	1x1	60x120	230x252	9.055x9.921	3.41	7.518	
	71 1041 1211	WRFFL 120 1x1 AISI 316	1x1	120x120	290x252	11.417x9.921	4.10	9.039	
	71 1041 1212	WRFFL 120 1x2 AISI 316	1x2	120x120	290x382	11.417x15.039	6.38	14.065	
	71 1041 1213	WRFFL 120 1x3 AISI 316	1x3	120x120	290x512	11.417x20.178	8.66	19.092	
	71 1041 1214	WRFFL 120 1x4 AISI 316	1x4	120x120	290x642	11.417x25.276	10.94	24.119	
	71 1041 1811	WRFFL 180 1x1 AISI 316	1x1	180x120	350x252	13.780x9.921	4.79	10.560	
	71 1041 1812	WRFFL 180 1x2 AISI 316	1x2	180x120	350x382	13.780x15.039	7.36	16.226	
	71 1041 1813	WRFFL 180 1x3 AISI 316	1x3	180x120	350x512	13.780x20.158	9.93	21.892	
	71 1041 1814	WRFFL 180 1x4 AISI 316	1x4	180x120	350x642	13.780x25.276	12.50	27.558	
	71 1041 2411	WRFFL 240 1x1 AISI 316	1x1	240x120	410x252	16.142x9.921	5.48	12.081	
	71 1041 2412	WRFFL 240 1x2 AISI 316	1x2	240x120	410x382	16.142x15.039	8.34	18.367	
	71 1041 2413	WRFFL 240 1x3 AISI 316	1x3	240x120	410x512	16.142x20.158	11.19	24.670	
	71 1041 2414	WRFFL 240 1x4 AISI 316	1x4	240x120	410x642	16.142x25.276	14.05	30.964	
	71 1043 0611	WRFFL 60 1x1 Galv	1x1	60x120	230x252	9.055x9.921	3.33	7.330	
	71 1043 1211	WRFFL 120 1x1 Galv	1x1	120x120	290x252	11.417x9.921	4.00	8.816	
	71 1043 1212	WRFFL 120 1x2 Galv	1x2	120x120	290x382	11.417x15.039	6.22	13.715	
	71 1043 1213	WRFFL 120 1x3 Galv	1x3	120x120	290x512	11.417x20.178	8.44	18.614	
	71 1043 1214	WRFFL 120 1x4 Galv	1x4	120x120	290x642	11.417x25.276	10.67	23.512	

WMR series									
PICTURE DISEGNO	CODE CODICE	ARTICLE ARTICOLO	OPENINGS APERTURE TELAIO	PACKING SPACE SPAZIO DI RIEMPIMENTO	EXTERNAL NOMINAL DIMENSIONS DIMENSIONI ESTERNE NOMINALI HxW (D=60mm)			WEIGHT PESO	
					mm	mm	in	kg	lb
	71 1043 1215	WRFFL 120 1x5 Galv	1x5	120x120	290x772	11.417x30.394	12.89	28.411	
	71 1043 1216	WRFFL 120 1x6 Galv	1x6	120x120	290x902	11.417x35.512	15.11	33.310	
	71 1043 1221	WRFFL 120 2x1 Galv	2x1	120x120	458x252	18.032x9.921	6.47	14.259	
	71 1043 1231	WRFFL 120 3x1 Galv	3x1	120x120	626x252	24.646x9.921	8.90	19.612	
	71 1043 1811	WRFFL 180 1x1 Galv	1x1	180x120	350x252	13.780x9.921	4.67	10.302	
	71 1043 1812	WRFFL 180 1x2 Galv	1x2	180x120	350x382	13.780x15.039	7.18	15.818	
	71 1043 1813	WRFFL 180 1x3 Galv	1x3	180x120	350x512	13.780x20.158	9.68	21.336	
	71 1043 1814	WRFFL 180 1x4 Galv	1x4	180x120	350x642	13.780x25.276	12.18	26.857	
	71 1043 1815	WRFFL 180 1x5 Galv	1x5	180x120	350x772	13.780x30.394	14.68	32.370	
	71 1043 1816	WRFFL 180 1x6 Galv	1x6	180x120	350x902	13.780x35.512	17.19	37.888	
	71 1043 1821	WRFFL 180 2x1 Galv	2x1	180x120	578x252	22.756x9.921	7.80	17.185	
	71 1043 1831	WRFFL 180 3x1 Galv	3x1	180x120	806x252	31.732x9.921	10.92	24.070	
	71 1043 2411	WRFFL 240 1x1 Galv	1x1	240x120	410x252	16.142x9.921	5.35	11.756	
	71 1043 2412	WRFFL 240 1x2 Galv	1x2	240x120	410x382	16.142x15.039	8.13	17.924	
	71 1043 2413	WRFFL 240 1x3 Galv	1x3	240x120	410x512	16.142x20.158	10.91	24.061	
	71 1043 2414	WRFFL 240 1x4 Galv	1x4	240x120	410x642	16.142x25.276	13.70	30.199	

WRFFLO

WallMax® Rectangular Flanged Frame Light Openable

WallMax® Rectangular Flanged Frame Light Openable

Cornice Rettangolare Leggera con Flangia Scomponibile WallMax®

WallMax® Rectangular Flanged Frames Light are structures with a 6mm thick flange and one wall opening.

A large variety of pre-designed, single and multiple opening combinations is offered, and additional customized solutions in terms of packing space and materials can be developed to accommodate specific customer's needs.

WRFFLO solutions are designed for installation where cables/pipes are already in place and it is not feasible to cut them and re-installed them.

They are supplied with a partially welded side. WRFFLO are designed for installation through casting in the wall or welding.

Le Cornici Rettangolari Leggere con Flangia sono telai con flangia di spessore 6mm, disponibili con apertura singola.

WallMax® dispone di un'ampia gamma di soluzioni ad apertura singola o multipla e, in aggiunta, offre al cliente la possibilità di personalizzare le cornici, sia per quanto riguarda le aperture che per quanto riguarda la scelta dei materiali.

I telai WRFFLO sono pensati per soluzioni di installazione dove sono già presenti dei cavi o tubi e il cliente vuole evitare di tagliarli e di conseguenza rigiuntarli.

Vengono forniti con un lato non completamente saldato.

Le cornici WRFFLO sono soluzioni di montaggio destinate all'installazione attraverso muratura o saldatura.

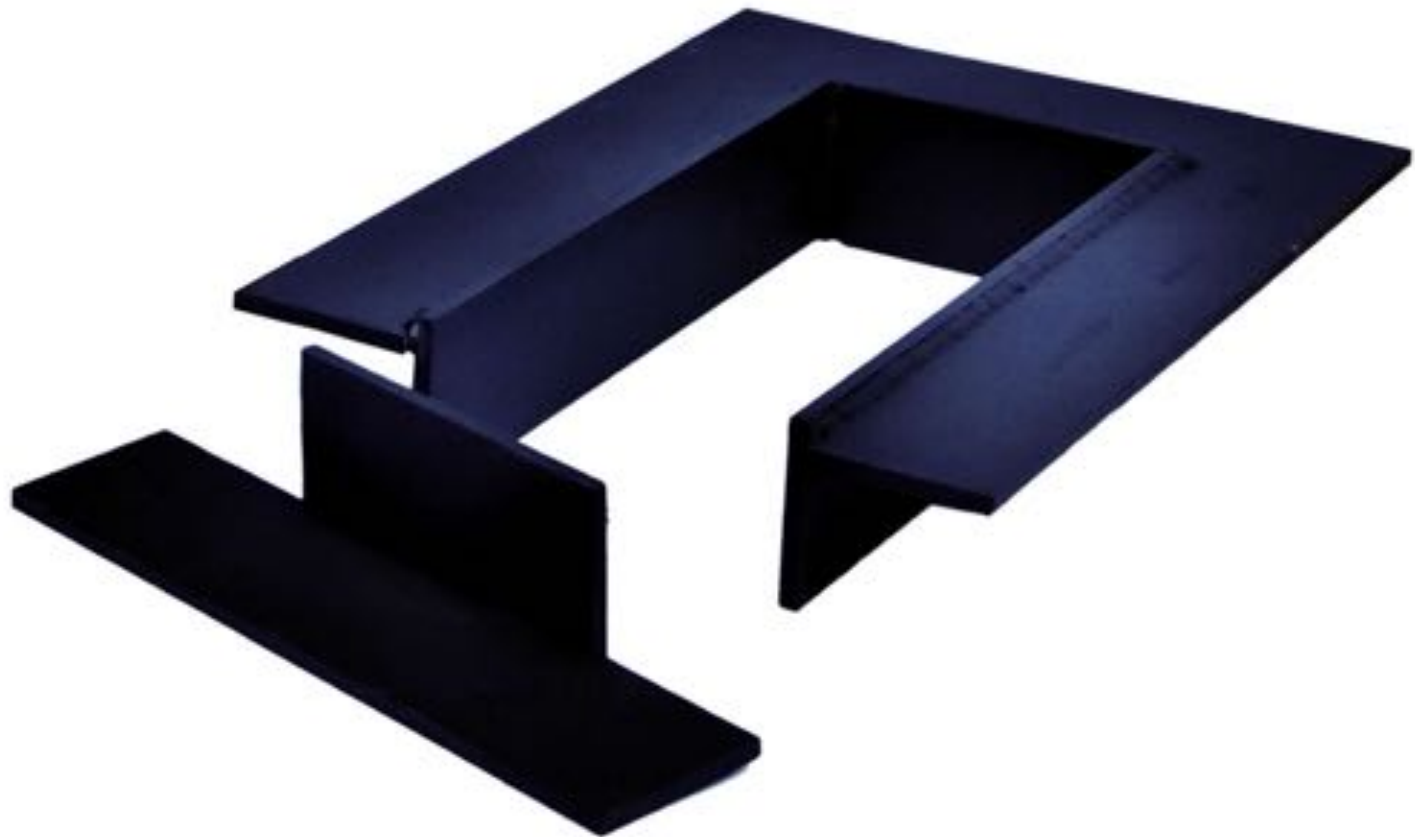

WallMax® Rectangular Flanged Frame Light Openable

Sealing solutions using WRFFLO frames are to be completed with a combination of WMR series modules and accessories selected according to customer-specific needs.

Cornice Rettangolare Leggera con Flangia Scomponibile

WallMax®

Le soluzioni di sigillatura con cornice WRFFLO sono pensate per l'utilizzo con i moduli e gli accessori della gamma WMR. Questi ultimi possono essere abbinati a piacimento per ottenere combinazioni di passaggio cavi completamente personalizzate.

MATERIALS	MATERIALI
SS AISI 316 L	Acciaio inox resistente agli acidi
Primed Steel	Acciaio con prima mano antiruggine
Galvanized Steel	Acciaio galvanizzato
Other materials available upon request	Disponibile in altri materiali su richiesta

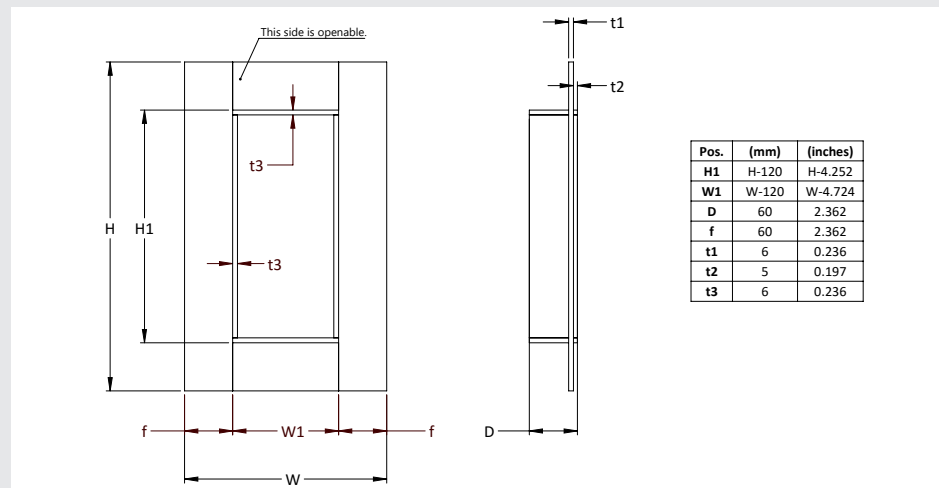

To be used in combination with/utilizzate in combinazione con

WMR series									
PICTURE DISEGNO	CODE CODICE	ARTICLE ARTICOLO	OPENINGS APERTURE TELAIO	PACKING SPACE SPAZIO DI RIEMPIMENTO mm	EXTERNAL NOMINAL DIMENSIONS DIMENSIONI ESTERNE NOMINALI HxW (D=60mm)			WEIGHT PESO	
					mm	mm	in	kg	lb
■	71 1440 0611	WRFFLO 60 - 1x1 Primed	1x1	60x120	230x252	9.055x9.921	3.33	7.330	
■	71 1440 1211	WRFFLO 120 - 1x1 Primed	1x1	120x120	290x252	11.417x9.921	4.00	8.816	
■	71 1440 1811	WRFFLO 180 - 1x1 Primed	1x1	180x120	350x252	13.780x9.921	4.67	10.302	
■	71 1440 2411	WRFFLO 240 - 1x1 Primed	1x1	240x120	410x252	16.142x9.921	5.35	11.756	
■	71 1441 0611	WRFFLO 60 1x1 AISI 316	1x1	60x120	230x252	9.055x9.921	3.41	7.515	
■	71 1441 1211	WRFFLO 120 1x1 AISI 316	1x1	120x120	290x252	11.417x9.921	4.10	9.041	
■	71 1441 1811	WRFFLO 180 1x1 AISI 316	1x1	180x120	350x252	13.780x9.921	4.79	10.564	
■	71 1441 2411	WRFFLO 240 1x1 AISI 316	1x1	240x120	410x252	16.142x9.921	5.48	12.081	
■	71 1443 0611	WRFFLO 60 1x1 Galv	1x1	60x120	230x252	9.055x9.921	3.33	7.330	
■	71 1443 1211	WRFFLO 120 1x1 Galv	1x1	120x120	290x252	11.417x9.921	4.00	8.816	
■	71 1443 1811	WRFFLO 180 1x1 Galv	1x1	180x120	350x252	13.780x9.921	4.67	10.302	
■	71 1443 2411	WRFFLO 240 1x1 Galv	1x1	240x120	410x252	16.142x9.921	5.35	11.756	

WRHFF

WallMax® Rectangular Holed Flanged Frame

WallMax® Rectangular Holed Flanged Frame

Cornice Rettangolare con Flangia Forata WallMax®

WallMax® Rectangular Holed Flanged Frames are alternative solutions to WRFF to be used where welding is not recommended.

WRHFF has a 10mm thick flange.

WRHFF frames can be assembled in a variety of combinations for what concerns both openings and construction materials. Pre-defined solutions as well as customized options are offered to adjust to client's needs. WRHFF are designed for installation through bolting or casting in the wall.

Le Cornici Rettangolari con Flangia Forata sono soluzioni alternative alle cornici WRFF, da usare quando la saldatura non è la soluzione ideale.

WRHFF ha una flangia spessa 10mm.

Le cornici WRHFF sono disponibili in varie combinazioni di aperture e in diversi materiali. E' possibile la personalizzazione su richiesta del cliente.

Le cornici WRHFF sono soluzioni di montaggio destinate all'installazione attraverso imbullonatura o muratura.



WallMax® Rectangular Holed
Flanged Frame

WRHFF frames are used in combination with WMR series and accessories to create personalized sealing solutions. Standard packing space allows for multiple combinations of WMR modules and a perfect fit to any customer's need.

Comice Rettangolare con
Flangia Forata WallMax®

Le cornici WRHFF sono da completare con i moduli della gamma WMR per ottenere soluzioni di sigillatura personalizzate. Sono possibili varie combinazioni di moduli di dimensioni differenti, a seconda delle necessità del cliente.

MATERIALS	MATERIALI
SS AISI 316 L	Acciaio inox resistente agli acidi
Primed Steel	Acciaio con prima mano antiruggine
Galvanized Steel	Acciaio galvanizzato
Other materials available upon request	Disponibile in altri materiali su richiesta

DATASHEET PAGE: 157

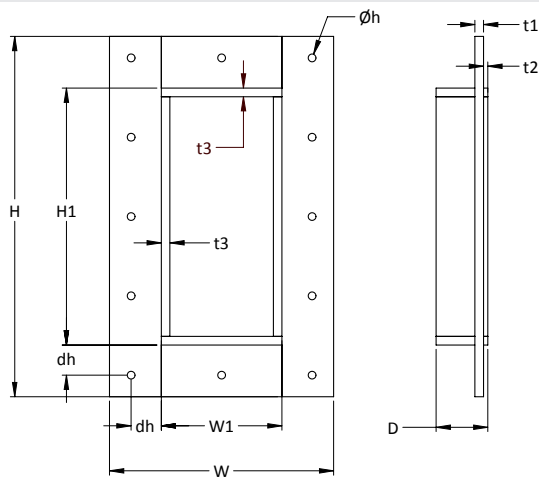

Pos.	(mm)	(inches)
H1	H-120	H-4.252
W1	W-120	W-4.724
D	60	2.362
f	60	2.362
t1	10	0.394
t2	5	0.197
t3	10	0.394
øh	9	0.354
dh	35	1.378

Note: The holes pattern depends on the size

To be used in combination with/utilizzate in combinazione con

WMR series									
PICTURE DISEGNO	CODE CODICE	ARTICLE ARTICOLO	OPENINGS APERTURE TELAIO	PACKING SPACE SPAZIO DI RIEMPIMENTO mm	EXTERNAL NOMINAL DIMENSIONI ESTERNE NOMINALI HxW (D=60mm) mm	DIMENSIONS in	WEIGHT PESO kg	lb	
	71 1020 0611	WRHFF 60 1x1 Primed	1x1	60x120	238x260	9.370x10.236	5.73	12.624	
	71 1020 0612	WRHFF 60 1x2 Primed	1x2	60x120	238x390	9.370x15.354	8.85	19.450	
	71 1020 0613	WRHFF 60 1x3 Primed	1x3	60x120	238x520	9.370x20.472	11.96	26.376	
	71 1020 1211	WRHFF 120 1x1 Primed	1x1	120x120	298x260	11.732x10.236	6.84	15.077	
	71 1020 1212	WRHFF 120 1x2 Primed	1x2	120x120	298x390	11.732x15.354	10.25	22.595	
	71 1020 1213	WRHFF 120 1x3 Primed	1x3	120x120	298x520	11.732x20.472	13.66	30.113	
	71 1020 1811	WRHFF 180 1x1 Primed	1x1	180x120	358x260	14.095x10.236	7.95	17.533	
	71 1020 1812	WRHFF 180 1x2 Primed	1x2	180x120	358x390	14.095x15.354	11.58	25.538	
	71 1020 1813	WRHFF 180 1x3 Primed	1x3	180x120	358x520	14.095x20.472	13.66	30.113	
	71 1020 2411	WRHFF 240 1x1 Primed	1x1	240x120	418x260	16.457x15.354	9.08	20.009	
	71 1021 0611	WRHFF 60 1x1 AISI 316	1x1	60x120	238x260	9.370x10.236	5.87	12.948	
	71 1021 0612	WRHFF 60 1x2 AISI 316	1x2	60x120	238x390	9.370x15.354	9.07	20.000	
	71 1021 0613	WRHFF 60 1x3 AISI 316	1x3	60x120	238x520	9.370x20.472	12.27	27.053	
	71 1021 1211	WRHFF 120 1x1 AISI 316	1x1	120x120	298x260	11.732x10.236	7.02	15.465	
	71 1021 1212	WRHFF 120 1x2 AISI 316	1x2	120x120	298x390	11.732x15.354	10.43	22.983	
	71 1021 1213	WRHFF 120 1x3 AISI 316	1x3	120x120	298x520	11.732x20.472	13.84	30.501	
	71 1021 1811	WRHFF 180 1x1 AISI 316	1x1	180x120	358x260	14.095x10.236	8.16	17.983	
	71 1021 1812	WRHFF 180 1x2 AISI 316	1x2	180x120	358x390	14.095x15.354	11.88	26.193	
	71 1021 1813	WRHFF 180 1x3 AISI 316	1x3	180x120	358x520	14.095x20.472	15.61	34.403	
	71 1021 2411	WRHFF 240 1x1 AISI 316	1x1	240x120	418x260	16.457x10.236	9.31	20.523	
	71 1023 0611	WRHFF 60 1x1 Galv	1x1	60x120	238x260	9.370x10.236	5.73	12.624	
	71 1023 0612	WRHFF 60 1x2 Galv	1x2	60x120	238x390	9.370x15.354	8.85	19.450	
	71 1023 0613	WRHFF 60 1x3 Galv	1x3	60x120	238x520	9.370x20.472	11.96	26.376	
	71 1023 1211	WRHFF 120 1x1 Galv	1x1	120x120	298x260	11.732x10.236	6.84	15.077	
	71 1023 1212	WRHFF 120 1x2 Galv	1x2	120x120	298x390	11.732x15.354	10.25	22.595	
	71 1023 1213	WRHFF 120 1x3 Galv	1x3	120x120	298x520	11.732x20.472	13.66	30.113	
	71 1023 1811	WRHFF 180 1x1 Galv	1x1	180x120	358x260	14.095x10.236	7.95	17.533	
	71 1023 1812	WRHFF 180 1x2 Galv	1x2	180x120	358x390	14.095x15.354	11.58	25.538	
	71 1023 1813	WRHFF 180 1x3 Galv	1x3	180x120	358x520	14.095x20.472	13.66	30.113	
	71 1023 2411	WRHFF 240 1x1 Galv	1x1	240x120	418x260	16.457x15.354	9.08	20.009	

WRHFFO

WallMax® Rectangular Holed
Flanged Frame Openable

WallMax®
Rectangular Holed
Flanged Frame
Openable

Cornice
Rettangolare con
Flangia Forata
Scomponibile
WallMax®

WallMax® Rectangular Holed Flanged Frames Openable are alternative solutions to WRFFO to be used where welding is not recommended.

WRHFFO has a 10mm thick flange. WRHFFO frames can be assembled in a variety of combinations for what concerns both openings and construction materials. Pre-defined solutions as well as customized options are offered to adjust to client's needs.

WRHFFO solutions are designed for installation where cables/pipes are already in place and it is not feasible to cut them and re-install them.

They are supplied with a partially welded side. WRHFFO are designed for installation through bolting or casting in the wall.

Le Cornici Rettangolari con Flangia Forata Scomponibile sono soluzioni alternative alle cornici WRFFO, da usare quando la saldatura non è la soluzione ideale.

WRHFFO ha una flangia spessa 10mm. Le cornici WRHFFO sono disponibili in varie combinazioni di aperture e in diversi materiali. E' possibile la personalizzazione su richiesta del cliente.

I telai WRHFFO sono pensati per soluzioni di installazione dove sono già presenti dei cavi o tubi e il cliente vuole evitare di tagliarli e di conseguenza rigiuntarli.

Vengono forniti con un lato non completamente saldato.

Le cornici WRHFFO sono soluzioni di montaggio destinate all'installazione attraverso imbullonatura o muratura.





**WallMax® Rectangular Holed
Flanged Frame Openable**

WRHFFO frames are used in combination with WMR series and accessories to create personalized sealing solutions. Standard packing space allows for multiple combinations of WMR modules and a perfect fit to any customer's need.

**Comice Rettangolare con
Flangia Forata Scomponibile
WallMax®**

Le cornici WRHFFO sono da completare con i moduli della gamma WMR per ottenere soluzioni di sigillatura personalizzate. Sono possibili varie combinazioni di moduli di dimensioni differenti, a seconda delle necessità del cliente.

MATERIALS	MATERIALI
SS AISI 316 L	Acciaio inox resistente agli acidi
Primed Steel	Acciaio con primamani di antiruggine
Galvanized Steel	Acciaio galvanizzato
Other materials available upon request	Disponibile in altri materiali su richiesta

To be used in combination with/utilizzate in combinazione con

WMR series									
PICTURE DISEGNO	CODE CODICE	ARTICLE ARTICOLO	OPENINGS APERTURE TELAIO	PACKING SPACE SPAZIO DI RIEMPIMENTO mm	EXTERNAL NOMINAL DIMENSIONS DIMENSIONI ESTERNE NOMINALI HxW (D=60mm)			WEIGHT PESO	
					mm	in	kg	lb	
	71 1450 0611	WRHFFO 60 1x1 Primed	1x1	60x120	238x260	9.370x10.236	5.63	12.412	
	71 1450 1211	WRHFFO 120 1x1 Primed	1x1	120x120	298x260	11.732x10.236	6.74	14.859	
	71 1450 1811	WRHFFO 180 1x1 Primed	1x1	180x120	358x260	14.095x10.236	7.85	17.306	
	71 1450 2411	WRHFFO 240 1x1 Primed	1x1	240x120	418x260	16.457x15.354	8.98	19.798	
	71 1451 0611	WRHFFO 60 1x1 AISI 316	1x1	60x120	238x260	9.370x10.236	5.67	12.500	
	71 1451 1211	WRHFFO 120 1x1 AISI 316	1x1	120x120	298x260	11.732x10.236	6.92	15.256	
	71 1451 1811	WRHFFO 180 1x1 AISI 316	1x1	180x120	358x260	14.095x10.236	8.06	17.769	
	71 1451 2411	WRHFFO 240 1x1 AISI 316	1x1	240x120	418x260	16.457x15.354	9.21	20.305	
	71 1453 0611	WRHFFO 60 1x1 Galv	1x1	60x120	230x252	9.055x9.921	5.63	12.412	
	71 1453 1211	WRHFFO 120 1x1 Galv	1x1	120x120	290x252	11.417x9.921	6.74	14.859	
	71 1453 1811	WRHFFO 180 1x1 Galv	1x1	180x120	350x252	13.780x9.921	7.85	17.306	
	71 1453 2411	WRHFFO 240 1x1 Galv	1x1	240x120	418x260	16.457x15.354	8.98	19.798	

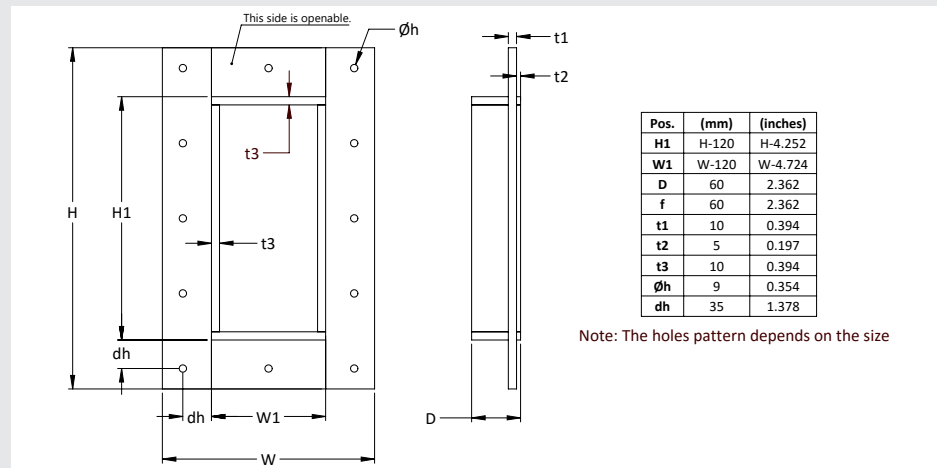

WRHFFL

WallMax® Rectangular Holed Flanged Frame Light

WallMax® Rectangular Holed Flanged Frame Light

WallMax® Rectangular Holed Flanged Frames Light are alternative solutions to WRFFL to be used where welding is not recommended.

WRHFFL has a 6mm thick flange.

WRHFFL frames can be assembled in a variety of combinations for what concerns both openings and construction materials. Pre-defined solutions as well as customized options are offered to adjust to client's needs.

WRHFFL are designed for installation through bolting or casting in the wall.

Cornice Rettangolare con Flangia Forata Leggera WallMax®

Le Cornici Rettangolari con Flangia Forata Leggera sono soluzioni alternative alle cornici WRFFL, da usare quando la saldatura non è la soluzione ideale.

WRHFFL ha una flangia spessa 6mm.

Le cornici WRHFFL sono disponibili in varie combinazioni di aperture e in diversi materiali. E' possibile la personalizzazione su richiesta del cliente.

Le cornici WRHFFL sono soluzioni di montaggio destinate all'installazione attraverso imbullonatura o muratura.





WallMax® Rectangular Holed
Flanged Frame Light

WRHFFL frames are used in combination with WMR series and accessories to create personalized sealing solutions. Standard packing space allows for multiple combinations of WMR modules and a perfect fit to any customer's need.

Cornice Rettangolare con
Flangia Forata Leggera
WallMax®

Le cornici WRHFFL sono da completare con i moduli della gamma WMR per ottenere soluzioni di sigillatura personalizzate. Sono possibili varie combinazioni di moduli di dimensioni differenti, a seconda delle necessità del cliente.

MATERIALS	MATERIALI
SS AISI 316 L	Acciaio inox resistente agli acidi
Primed Steel	Acciaio con prima mano antiruggine
Galvanized Steel	Acciaio galvanizzato
Other materials available upon request	Disponibile in altri materiali su richiesta

DATASHEET PAGE: 158

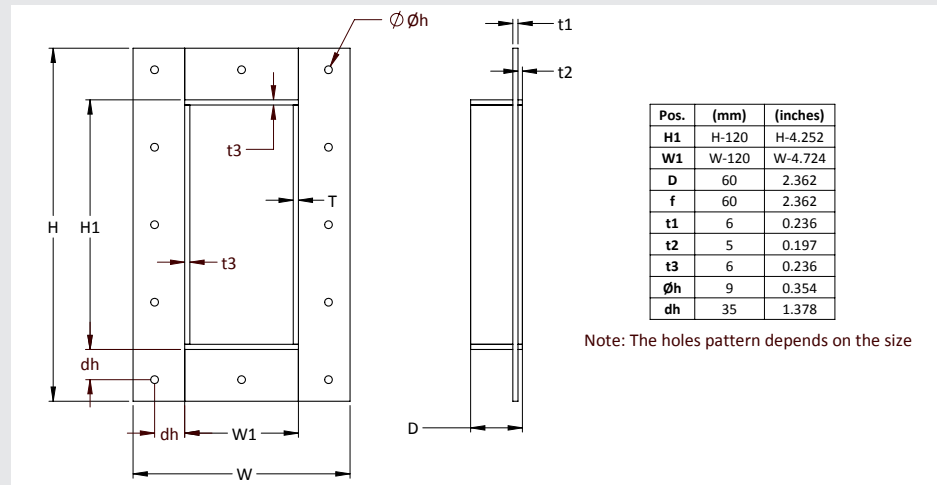

To be used in combination with/utilizzate in combinazione con

WMR series		OPENINGS APERTURE TELAIO	PACKING SPACE SPAZIO DI RIEMPIMENTO	EXTERNAL NOMINAL DIMENSIONS DIMENSIONI ESTERNE NOMINALI		WEIGHT PESO	
PICTURE DISEGNO	CODE CODICE	ARTICLE ARTICOLO	mm	mm	in	kg	lb
	71 1230 0611	WRHFFL 60 1x1 Primed	1x1	60x120	230x252	9.055x9.921	3.30 7.277
	71 1230 0612	WRHFFL 60 1x2 Primed	1x2	60x120	230x382	9.055x15.039	5.24 11.543
	71 1230 0613	WRHFFL 60 1x3 Primed	1x3	60x120	230x512	9.055x20.158	7.17 15.809
	71 1230 1211	WRHFFL 120 1x1 Primed	1x1	120x120	290x252	11.417x9.921	3.97 8.755
	71 1230 1212	WRHFFL 120 1x2 Primed	1x2	120x120	290x382	11.417x15.039	6.19 13.638
	71 1230 1213	WRHFFL 120 1x3 Primed	1x3	120x120	290x512	11.417x20.178	8.40 18.251
	71 1230 1811	WRHFFL 180 1x1 Primed	1x1	180x120	350x252	13.780x9.921	4.64 10.232
	71 1230 1812	WRHFFL 180 1x2 Primed	1x2	180x120	350x382	13.780x15.039	7.15 15.754
	71 1230 1813	WRHFFL 180 1x3 Primed	1x3	180x120	350x512	13.780x20.157	9.64 21.255
	71 1230 2411	WRHFFL 240 1x1 Primed	1x1	240x120	410x252	16.142x9.921	5.32 11.731
	71 1231 0611	WRHFFL 60 1x1 AISI 316	1x1	60x120	230x252	9.055x9.921	3.38 7.454
	71 1231 0612	WRHFFL 60 1x2 AISI 316	1x2	60x120	230x382	9.055x15.039	5.32 11.720
	71 1231 0613	WRHFFL 60 1x3 AISI 316	1x3	60x120	230x512	9.055x20.158	7.25 15.986
	71 1231 1211	WRHFFL 120 1x1 AISI 316	1x1	120x120	290x252	11.417x9.921	4.07 8.975
	71 1231 1212	WRHFFL 120 1x2 AISI 316	1x2	120x120	290x382	11.417x15.039	6.35 14.002
	71 1231 1213	WRHFFL 120 1x3 AISI 316	1x3	120x120	290x512	11.417x20.178	8.63 19.028
	71 1231 1811	WRHFFL 180 1x1 AISI 316	1x1	180x120	350x252	13.780x9.921	4.76 10.496
	71 1231 1812	WRHFFL 180 1x2 AISI 316	1x2	180x120	350x382	13.780x15.039	7.33 16.162
	71 1231 1813	WRHFFL 180 1x3 AISI 316	1x3	180x120	350x512	13.780x20.157	9.90 21.828
	71 1231 2411	WRHFFL 240 1x1 AISI 316	1x1	240x120	410x252	16.142x9.921	5.45 12.017
	71 1233 0611	WRHFFL 60 1x1 Galv	1x1	60x120	230x252	9.055x9.921	3.30 7.277
	71 1233 0612	WRHFFL 60 1x2 Galv	1x2	60x120	230x382	9.055x15.039	5.24 11.543
	71 1233 0613	WRHFFL 60 1x3 Galv	1x3	60x120	230x512	9.055x20.158	7.17 15.809
	71 1233 1211	WRHFFL 120 1x1 Galv	1x1	120x120	290x252	11.417x9.921	3.97 8.755
	71 1233 1212	WRHFFL 120 1x2 Galv	1x2	120x120	290x382	11.417x15.039	6.19 13.638
	71 1233 1213	WRHFFL 120 1x3 Galv	1x3	120x120	290x512	11.417x20.178	8.40 18.251
	71 1233 1811	WRHFFL 180 1x1 Galv	1x1	180x120	350x252	13.780x9.921	4.64 10.232
	71 1233 1812	WRHFFL 180 1x2 Galv	1x2	180x120	350x382	13.780x15.039	7.15 15.754
	71 1233 1813	WRHFFL 180 1x3 Galv	1x3	180x120	350x512	13.780x20.157	9.64 21.255
	71 1233 2411	WRHFFL 240 1x1 Galv	1x1	240x120	410x252	16.142x9.921	5.32 11.731

WRHFFLO

WallMax® Rectangular Holed
Flanged Frame Light Openable

WallMax®
Rectangular Holed
Flanged Frame
Light Openable

Cornice
Rettangolare
con Flangia
Forata Leggera
Scomponibile
WallMax®

WallMax® Rectangular Holed Flanged Frames Light Openable are alternative solutions to WRFFLO to be used where welding is not recommended.

WRHFFLO has a 6mm thick flange.

WRHFFLO frames can be assembled in a variety of combinations for what concerns both openings and construction materials. Pre-defined solutions as well as customized options are offered to adjust to client's needs.

WRHFFLO solutions are designed for installation where cables/pipes are already in place and it is not feasible to cut them and re-installed them.

They are supplied with a partially welded side. WRHFFLO are designed for installation through bolting or casting in the wall.

Le Cornici Rettangolari con Flangia Forata Leggera Scomponibile sono soluzioni alternative alle cornici WRFFLO, da usare quando la saldatura non è la soluzione ideale.

WRHFFLO ha una flangia spessa 6mm. Le cornici WRHFFLO sono disponibili in varie combinazioni di materiali.

E' possibile la personalizzazione su richiesta del cliente.

I telai WRHFFLO sono pensati per soluzioni di installazione dove sono già presenti dei cavi o tubi e il cliente vuole evitare di tagliarli e di conseguenza rigiuntarli.

Vengono forniti con un lato non completamente saldato.

Le cornici WRHFFLO sono soluzioni di montaggio destinate all'installazione attraverso imbullonatura o muratura.





WallMax® Rectangular Holed Flanged Frame Light Openable

WRHFFLO frames are used in combination with WMR series and accessories to create personalized sealing solutions. Standard packing space allows for multiple combinations of WMR modules and a perfect fit to any customer's need.

Cornice Rettangolare con Flangia Forata Leggera Scomponibile WallMax®

Le cornici WRHFFLO sono da completare con i moduli della gamma WMR per ottenere soluzioni di sigillatura personalizzate. Sono possibili varie combinazioni di moduli di dimensioni differenti, a seconda delle necessità del cliente.

MATERIALS	MATERIALI
SS AISI 316 L	Acciaio inox resistente agli acidi
Primed Steel	Acciaio con prima mano antiruggine
Galvanized Steel	Acciaio galvanizzato
Other materials available upon request	Disponibile in altri materiali su richiesta

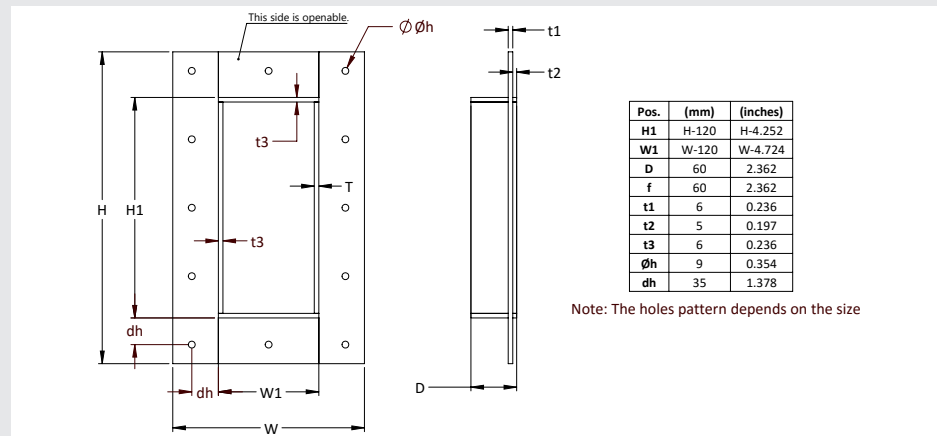

To be used in combination with/utilizzate in combinazione con

WMR series									
PICTURE DISEGNO	CODE CODICE	ARTICLE ARTICOLO	OPENINGS APERTURE TELAIO	PACKING SPACE SPAZIO DI RIEMPIMENTO mm	EXTERNAL NOMINAL DIMENSIONS DIMENSIONI ESTERNE NOMINALI HxW (D=60mm)			WEIGHT PESO	
					mm	in	kg	lb	
■	*	WRHFFLO 60 1x1 Primed	1x1	60x120	238x260	9.370x10.236	3.28	7.233	
■	*	WRHFFLO 120 1x1 Primed	1x1	120x120	298x260	11.732x10.236	3.95	8.710	
■	*	WRHFFLO 180 1x1 Primed	1x1	180x120	358x260	14.095x10.236	4.62	10.188	
■	*	WRHFFLO 240 1x1 Primed	1x1	240x120	418x260	16.457x15.354	5.30	11.687	
■	*	WRHFFLO 60 1x1 AISI 316	1x1	60x120	238x260	9.370x10.236	3.36	7.410	
■	*	WRHFFLO 120 1x1 AISI 316	1x1	120x120	298x260	11.732x10.236	4.05	8.931	
■	*	WRHFFLO 180 1x1 AISI 316	1x1	180x120	358x260	14.095x10.236	4.70	10.364	
■	*	WRHFFLO 240 1x1 AISI 316	1x1	240x120	418x260	16.457x15.354	5.45	12.015	
■	*	WRHFFLO 60 1x1 Galv	1x1	60x120	230x252	9.055x9.921	3.28	7.233	
■	*	WRHFFLO 120 1x1 Galv	1x1	120x120	290x252	11.417x9.921	3.95	8.710	
■	*	WRHFFLO 180 1x1 Galv	1x1	180x120	350x252	13.780x9.921	4.62	10.188	
■	*	WRHFFLO 240 1x1 Galv	1x1	240x120	418x260	16.457x15.354	5.30	11.687	

* Please for the part number contact the Sales Department

WMF

WallMax® Modular Frame

WallMax® Modular Frame

WallMax® Modular Frames are rectangular structures made of different angular and flat parts, which can be assembled together through bolts and nuts to create either single or multiple openings for modules. WMF frames are modular solutions where the separate parts can be combined and assembled around existing installations, thus allowing special ease of mounting. WMF are solutions designed for installation through bolting or casting in the wall.

Cornice Modulare WallMax®

Le Cornici Modulari WallMax® sono strutture rettangolari composte da parti separate, assemblabili in combinazioni differenti per creare aperture a muro singole o multiple per il passaggio di cavi. Il telaio combinabile WMF è pensato per il montaggio attorno a installazioni già esistenti. La struttura modulare permette infatti di modificare le soluzioni di sigillatura presenti, senza alterare il passaggio dei cavi. Le cornici WMF sono soluzioni di montaggio destinate all'installazione attraverso imbullonatura o muratura.





WallMax® Modular Frame

Modular Frames are used in combination with WMR series modules and accessories, including expanders and retainer plates. While the pieces are bolted together, the complete frame is designed for bolting and casting in the wall.

Cornice Modulare WallMax®

Le cornici WMF sono da utilizzare in combinazione con i moduli WMR e i relativi accessori, tra cui le unità di compressione WE e le piastre di contenimento WRP. I singoli pezzi di ogni cornice sono assemblabili tra loro tramite viti e bulloni; la cornice completa è invece da fissare tramite imbullonatura o muratura.

MATERIALS	MATERIALI
Galvanized Steel	Acciaio galvanizzato
Other materials available upon request	Disponibile in altri materiali su richiesta

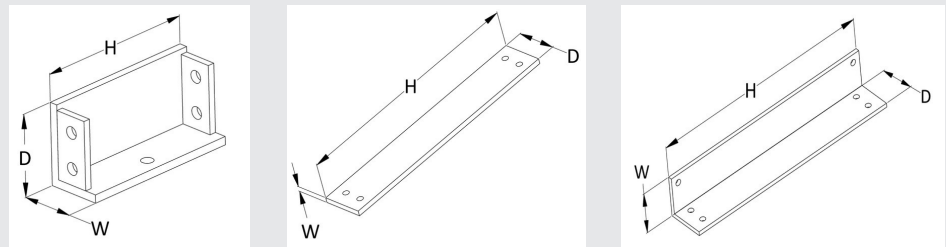

To be used in combination with/utilizzate in combinazione con

DATASHEET PAGE:159

WMR series						
CODE	ARTICLE	PACKING SPACE	EXTERNAL DIMENSIONS		PESO	
CODICE	ARTICOLO	SPAZIO DI RIEMPIMENTO	DIMENSIONI ESTERNE		WEIGHT	
		mm	mm	in	kg	lb
71 1033 0512	WMF ANG SS 120 Galv	width=120mm	120x40	4.724x1.575	0.53	1.168
71 1033 0518	WMF ANG LS 60 Galv	60x120	181x40	7.126x1.575	0.94	2.077
71 1033 0524	WMF ANG LS 120 Galv	120x120	240x40	9.449x1.575	1.26	2.784
71 1033 0529	WMF ANG LS 180 Galv	180x120	290x40	11.417x1.575	1.57	3.466
71 1033 0535	WMF ANG LS 240 Galv	240x120	358x40	14.094x1.575	1.94	4.279
71 1033 0818	WMF PLATE 60 Galv	60x120	181x8	7.126x0.315	0.65	1.435
71 1033 0824	WMF PLATE 120 Galv	120x120	240x8	9.449x0.315	0.88	1.929
71 1033 0829	WMF PLATE 180 Galv	180x120	298x8	11.732x0.315	1.10	2.425
71 1033 0835	WMF PLATE 240 Galv	240x120	358x8	9.449x0.315	1.32	2.919

WMR series						
PICTURE	CODE	ARTICLE	OPENINGS	PACKING SPACE	EXTERNAL NOMINAL DIMENSIONS	
DISEGNO	CODICE	ARTICOLO	APERTURE TELAIO	SPAZIO DI RIEMPIMENTO	DIMENSIONI ESTERNE NOMINALI	
				mm	mm	in
	71 1033 0611	WMF 60 1x1 Galv	1x1	60x120	178x240	7.008x9.449
	71 1033 0612	WMF 60 1x2 Galv	1x2	60x120	178x368	7.008x14.448
	71 1033 0613	WMF 60 1x3 Galv	1x3	60x120	178x496	7.008x19.526
	71 1033 0614	WMF 60 1x4 Galv	1x4	60x120	178x624	7.008x24.567
	71 1033 0615	WMF 60 1x5 Galv	1x5	60x120	178x752	7.008x29.606
	71 1033 0616	WMF 60 1x6 Galv	1x6	60x120	178x880	7.008x34.646
	71 1033 1211	WMF 120 1x1 Galv	1x1	120x120	238x240	9.370x9.449
	71 1033 1212	WMF 120 1x2 Galv	1x2	120x120	238x368	9.370x14.448
	71 1033 1213	WMF 120 1x3 Galv	1x3	120x120	238x496	9.370x19.526
	71 1033 1214	WMF 120 1x4 Galv	1x4	120x120	238x624	9.370x24.567
	71 1033 1215	WMF 120 1x5 Galv	1x5	120x120	238x752	9.370x29.606
	71 1033 1216	WMF 120 1x6 Galv	1x6	120x120	238x880	9.370x34.646
	71 1033 1811	WMF 180 1x1 Galv	1x1	180x120	298x240	11.732x9.449
	71 1033 1812	WMF 180 1x2 Galv	1x2	180x120	298x368	11.732x14.448
	71 1033 1813	WMF 180 1x3 Galv	1x3	180x120	298x496	11.732x19.526
	71 1033 1814	WMF 180 1x4 Galv	1x4	180x120	298x624	11.732x24.567
	71 1033 1815	WMF 180 1x5 Galv	1x5	180x120	298x752	11.732x29.606
	71 1033 1816	WMF 180 1x6 Galv	1x6	180x120	298x880	11.732x34.646
	71 1033 2411	WMF 240 1x1 Galv	1x1	240x120	358x240	14.094x9.449
	71 1033 2412	WMF 240 1x2 Galv	1x2	240x120	358x368	14.094x14.448
	71 1033 2413	WMF 240 1x3 Galv	1x3	240x120	358x496	14.094x19.526
	71 1033 2414	WMF 240 1x4 Galv	1x4	240x120	358x624	14.094x24.567
	71 1033 2415	WMF 240 1x5 Galv	1x5	240x120	358x752	14.094x29.606
	71 1033 2416	WMF 240 1x6 Galv	1x6	240x120	358x880	14.094x34.646

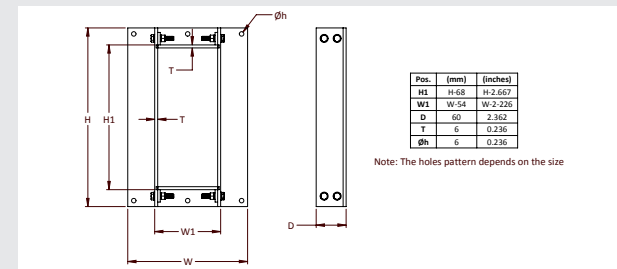

WM mini

WM mini

WM mini

WallMax® mini frames are lightweight mounting solution that can be installed from inside or outside on a cabinet, to seal the passage of cables through points of ingress. Mini frames are made of light cast aluminium and are built with an integrated expander, with packing space designed to accommodate module combinations without need for retainer plates, to further reduce weight.

To meet installers' needs WallMax® mini frames come in two versions: Mini Top, with compression unit accessible from the top of the frame, and Mini Back, with access to the expander unit from the back.

Mini frames are used with WallMax® Modules Compact (depth=30mm).

Both pre-defined combinations of modules and customized solutions are available. WM mini are designed for installation through bolting.

WM mini

Le cornici WallMax® mini sono soluzioni di montaggio leggere, che possono essere installate sia all'interno che all'esterno di cabinet per sigillare i punti di passaggio cavi. Le cornici di alluminio dispongono infatti di un'unità di compressione integrata, che non necessita di piastre di contenimento.

Per soddisfare le esigenze degli installatori le cornici WallMax® mini sono disponibili in due versioni: Mini Top, con un'unità di compressione accessibile dalla parte superiore del telaio e Mini Back, con accesso all'unità di espansione dal retro.

I mini frame vengono utilizzati con i moduli compatti WallMax® (profondità = 30 mm) per creare soluzioni di passaggio cavi personalizzate.

Le cornici WM mini sono soluzioni di montaggio destinate all'installazione attraverso imbullonatura.





WM mini Top

The mini Top series is available as frame only or as pre-assembled kits with a pre-defined module combination. The kits are easily mounted and reassembled.

WM mini Top

I telai della serie mini Top sono disponibili con o senza kit di moduli pre-assemblati, facilmente montabili e pronti all'uso.

MATERIAL	MATERIALE
Aluminium	Alluminio

DATASHEET PAGE: 166

To be used in combination with/utilizzate in combinazione con

WMC series						
CODE	ARTICLE	PACKING SPACE	EXTERNAL DIMENSIONS		PESO	
CODICE	ARTICOLO	SPAZIO DI RIEMPIMENTO	DIMENSIONI ESTERNE		WEIGHT	
		mm	mm	in	kg	lb
71 2023 1011	WM mini Top 4-10 1x1	100x40	173x80	6.811x3.146	0.46	0.931
71 2023 1211	WM mini Top 4-12 1x1	120x40	216x88	8.504x3.465	0.59	1.195
71 2023 1611	WM mini Top 4-16 1x1	160x40	233x80	9.173x3.150	0.54	1.093
71 2023 1612	WM mini Top 4-16 1x2	2x(160x40)	241x135	9.488x5.315	1.02	2.065
71 2023 1511	WM mini Top 5-15 1x1	150x50	223x92	8.779x3.622	0.59	1.195
71 2023 1512	WM mini Top 5-15 1x2	2x(150x50)	231x155	9.094x6.102	1.21	2.450

To be used in combination with/utilizzate in combinazione con

WMC series												
CODE	ARTICLE	MODULES COMBINATIONS							PACKING SPACES		WEIGHT	
CODICE	ARTICOLO	COMBINAZIONE MODULI							PESO		PESO	
		WMC 15w40 (2.5-11.5) mm	WMC 20w40 (4-16.5) mm	WMC 30w40 (10-25) mm	WMC 40 (21.5-34.5) mm	WMC 40 10-34	WMS 10x40	WMS 5x40	mm	kg	lb	
71 2023 1011.01	WM mini Top 4-10 1x1-10	0	5	0	0	0	0	0	100x40	0.59	1.292	
71 2023 1011.02	WM mini Top 4-10 1x1-16	4	2	0	0	0	0	0	100x40	0.59	1.292	
71 2023 1011.03	WM mini Top 4-10 1x1-3	0	0	3	0	0	1	0	100x40	0.59	1.292	
71 2023 1011.04	WM mini Top 4-10 1x1-11	2	2	1	0	0	0	0	100x40	0.59	1.292	
71 2023 1011.05	WM mini Top 4-10 1x1-12	2	3	0	0	0	1	0	100x40	0.59	1.292	

To be used in combination with/utilizzate in combinazione con

WMC series												
CODE	ARTICLE	MODULES COMBINATIONS							PACKING SPACES		WEIGHT	
CODICE	ARTICOLO	COMBINAZIONE MODULI							PESO		PESO	
		WMC 15w40 (2.5-11.5) mm	WMC 20w40 (4-16.5) mm	WMC 30w40 (10-25) mm	WMC 40 (21.5-34.5) mm	WMC 40 10-34	WMS 10x40	WMS 5x40	mm	kg	lb	
71 2023 1011.06	WM mini Top 4-10 1x1-4	0	1	0	2	0	0	0	100x40	0.59	1.292	
71 2023 1011.07	WM mini Top 4-10 1x1-7	0	3	0	1	0	0	0	100x40	0.5	1.292	
71 2023 1011.08	WM mini Top 4-10 1x1-4	0	1	0	2	0	0	0	100x40	0.59	1.292	
71 2023 1211.01	WM mini Top 4-12 1x1-12	0	6	0	0	0	0	0	120x40	0.75	1.649	
71 2023 1211.02	WM mini Top 4-12 1x1-24	8	0	0	0	0	0	0	120x40	0.75	1.649	
71 2023 1211.03	WM mini Top 4-12 1x1-4	0	0	4	0	0	0	0	120x40	0.75	1.649	
71 2023 1211.04	WM mini Top 4-12 1x1-3	0	0	0	0	3	0	0	120x40	0.75	1.649	
71 2023 1211.05	WM mini Top 4-12 1x1-9	0	4	0	0	1	0	0	120x40	0.75	1.649	
71 2023 1211.06	WM mini R 4-12 1x1-6	0	2	0	0	2	0	0	120x40	0.75	1.649	
71 2023 1211.07	WM mini Top 4-12 1x1-18	4	3	0	0	0	0	0	120x40	0.75	1.649	
71 2023 1611.01	WM mini Top 4-16 1x1-16	0	8	0	0	0	0	0	160x40	0.79	1.741	
71 2023 1611.02	WM mini Top 4-16 1x1-22	4	5	0	0	0	0	0	160x40	0.79	1.741	
71 2023 1611.03	WM mini Top 4-16 1x1-5	0	0	5	0	0	1	0	160x40	0.79	1.741	
71 2023 1611.04	WM mini Top 4-16 1x1-4	0	0	0	0	4	0	0	160x40	0.79	1.741	
71 2023 1611.05	WM mini Top 4-16 1x1-14	2	3	1	1	0	0	0	160x40	0.79	1.741	
71 2023 1611.06	WM mini Top 4-16 1x1-13	0	6	0	0	0	0	0	160x40	0.79	1.741	
71 2023 1611.07	WM mini Top 4-16 1x1-19	4	3	0	0	1	0	0	160x40	0.79	1.741	
71 2023 1611.08	WM mini Top 4-16 1x1-24	6	3	0	0	0	1	0	160x40	0.79	1.741	
71 2023 1611.09	WM mini Top 4-16 1x1-7	0	2	0	0	3	0	0	160x40	0.79	1.741	
71 2023 1611.10	WM mini Top 4-16 1x1-10	0	4	0	0	2	0	0	160x40	0.79	1.741	
71 2023 1612.01	WM mini Top 4-16 1x2-32	0	16	0	0	0	0	0	2x(160x40)	1.40	3.082	
71 2023 1612.02	WM mini Top 4-16 1x2-20	0	8	0	0	4	0	0	2x(160x40)	1.40	3.082	
71 2023 1612.03	WM mini Top 4-16 1x2-14	0	4	0	0	6	0	0	2x(160x40)	1.40	3.082	
71 2023 1612.04	WM mini Top 4-16 1x2-8	0	0	0	0	8	0	0	2x(160x40)	1.40	3.082	
71 2023 1612.05	WM mini Top 4-16 1x2-11	0	0	8	1	0	2	0	2x(160x40)	1.40	3.082	
71 2023 1612.06	WM mini Top 4-16 1x2-16	0	4	8	0	0	0	0	2x(160x40)	1.40	3.082	
71 2023 1612.07	WM mini Top 4-16 1x2-26	0	12	0	0	2	0	0	2x(160x40)	1.40	3.082	
71 2023 1612.08	WM mini Top 4-16 1x2-60	20	0	0	0	0	2	0	2x(160x40)	1.40	3.082	

NOTE: Weights are approximate.
NOTA: I pesi dichiarati sono indicativi.

WMC series

CODE CODICE	ARTICLE ARTICOLO	MODULES COMBINATIONS COMBINAZIONE MODULI							PACKING SPACES mm	WEIGHT PESO	
		WMC 15w40 (2.5-11.5) mm	WMC 20w40 (4-16.5) mm	WMC 30w40 (10-25) mm	WMC 40 (21.5-34.5) mm	WMC 40 10-34	WMS 10x40	WMS 5x40		kg	lb
71 2023 1612.09	WM mini Top 4-16 1x2-19	0	7	3	0	2	1	0	2x(160x40)	1.40	3.082
71 2023 1612.10	WM mini Top 4-16 1x2-18	0	6	4	0	2	0	0	2x(160x40)	1.40	3.082
71 2023 1612.11	WM mini Top 4-16 1x2-38	8	6	0	0	2	0	0	2x(160x40)	1.40	3.082
71 2023 1612.12	WM mini Top 4-16 1x2-10	0	0	10	0	0	2	0	2x(160x40)	1.40	3.082
71 2023 1612.13	WM mini Top 4-16 1x2-17	0	6	0	0	5	0	0	2x(160x40)	1.40	3.082

WMC series

CODE CODICE	ARTICLE ARTICOLO	PACKING SPACE SPAZIO DI RIEMPIMENTO mm	WMC 50 (28-44) mm	WMC 50 10-44	PESO WEIGHT	
					kg	lb
71 2023 1511.01	WM mini Top 5-15 1x1-3	150x50	3	0	0.86	1.895
71 2023 1511.02	WM mini Top 5-15 1x1-3	150x50	0	3	0.86	1.895
71 2023 1512.01	WM mini Top 5-15 1x2-6	2x(150x50)	0	6	1.74	3.836
71 2023 1512.02	WM mini Top 5-15 1x2-6	2x(150x50)	6	0	1.74	3.836



WM mini Back

The mini Back series is available as frame only or as pre-assembled kits with a pre-defined module combination. The kits are easily mounted and reassembled.

WM mini Back

I telai della serie mini Back sono disponibili con o senza kit di moduli pre-assemblati, facilmente montabili e pronti all'uso.

MATERIAL	MATERIALE
Aluminium	Alluminio

DATASHEET PAGE: 167

To be used in combination with/utilizzate in combinazione con

WMC series

CODE CODICE	ARTICLE ARTICOLO	PACKING SPACE SPAZIO DI RIEMPIMENTO mm	EXTERNAL DIMENSIONS DIMENSIONI ESTERNE HxW (D=30mm)		PESO WEIGHT	
			mm	in	kg	lb
71 2024 1011	WM mini Back 4-10 1x1	100x40	173x80	6.811x3.146	0.42	0.850
71 2024 1211	WM mini Back 4-12 1x1	120x40	216x88	8.504x3.465	0.54	1.093
71 2024 1611	WM mini Back 4-16 1x1	160x40	233x80	9.173x3.150	0.50	1.012
71 2024 1612	WM mini Back 4-16 1x2	2x(160x40)	241x135	9.488x5.315	0.93	1.883
71 2024 1511	WM mini Back 5-15 1x1	150x50	223x92	8.779x3.622	0.52	1.053
71 2024 1512	WM mini Back 5-15 1x2	2x(150x50)	231x155	9.094x6.102	1.09	2.207

To be used in combination with/utilizzate in combinazione con

WMC series

CODE CODICE	ARTICLE ARTICOLO	MODULES COMBINATIONS COMBINAZIONE MODULI							PACKING SPACES mm	WEIGHT PESO	
		WMC 15w40 (2.5-11.5) mm	WMC 20w40 (4-16.5) mm	WMC 30w40 (10-25) mm	WMC 40 (21.5-34.5) mm	WMC 40 10-34	WMS 10x40	WMS 5x40		kg	lb
71 2024 1011.01	WM mini Back 4-10 1x1-10	0	5	0	0	0	0	0	100x40	0.54	1.190
71 2024 1011.02	WM mini Back 4-10 1x1-16	4	2	0	0	0	0	0	100x40	0.54	1.190
71 2024 1011.03	WM mini Back 4-10 1x1-3	0	0	3	0	0	1	0	100x40	0.54	1.190
71 2024 1011.04	WM mini Back 4-10 1x1-11	2	2	1	0	0	0	0	100x40	0.54	1.190

WMC series

CODE CODICE	ARTICLE ARTICOLO	MODULES COMBINATIONS COMBINAZIONE MODULI							PACKING SPACES mm	WEIGHT PESO	
		WMC 15w40 (2.5-11.5) mm	WMC 20w40 (4-16.5) mm	WMC 30w40 (10-25) mm	WMC 40 (21.5-34.5) mm	WMC 40 10-34	WMS 10x40	WMS 5x40		kg	lb
71 2024 1011.05	WM mini Back 4-10 1x1-12	2	3	0	0	0	1	0	100x40	0.54	1.190
71 2024 1011.06	WM mini Back 4-10 1x1-4	0	1	0	2	0	0	0	100x40	0.54	1.190
71 2024 1011.07	WM mini Back 4-10 1x1-7	0	3	0	0	1	0	0	100x40	0.54	1.190
71 2024 1011.08	WM mini Back 4-10 1x1-4	0	1	0	0	2	0	0	100x40	0.54	1.190
71 2024 1211.01	WM mini Back 4-12 1x1-12	0	6	0	0	0	0	0	120x40	0.70	1.543
71 2024 1211.02	WM mini Back 4-12 1x1-24	8	0	0	0	0	0	0	120x40	0.70	1.543
71 2024 1211.03	WM mini Back 4-12 1x1-4	0	0	4	0	0	0	0	120x40	0.70	1.543
71 2024 1211.04	WM mini Back 4-12 1x1-3	0	0	0	0	3	0	0	120x40	0.70	1.543
71 2024 1211.05	WM mini Back 4-12 1x1-9	0	4	0	0	1	0	0	120x40	0.70	1.543
71 2024 1211.06	WM mini Back 4-12 1x1-6	0	2	0	0	2	0	0	120x40	0.70	1.543
71 2024 1211.07	WM mini Back 4-12 1x1-18	4	3	0	0	0	0	0	120x40	0.70	1.543
71 2024 1611.01	WM mini Back 4-16 1x1-16	0	8	0	0	0	0	0	160x40	0.74	1.631
71 2024 1611.02	WM mini Back 4-16 1x1-22	4	5	0	0	0	0	0	160x40	0.74	1.631
71 2024 1611.03	WM mini Back 4-16 1x1-5	0	0	5	0	0	1	0	160x40	0.74	1.631
71 2024 1611.04	WM mini Back 4-16 1x1-4	0	0	0	0	4	0	0	160x40	0.74	1.631
71 2024 1611.05	WM mini Back 4-16 1x1-14	2	3	1	0	1	0	0	160x40	0.74	1.631
71 2024 1611.06	WM mini Back 4-16 1x1-13	0	6	0	0	1	0	0	160x40	0.74	1.631
71 2024 1611.07	WM mini Back 4-16 1x1-19	4	3	0	0	1	0	0	160x40	0.74	1.631
71 2024 1611.08	WM mini Back 4-16 1x1-24	6	3	0	0	0	1	0	160x40	0.74	1.631
71 2024 1611.09	WM mini Back 4-16 1x1-7	0	2	0	0	3	0	0	160x40	0.74	1.631
71 2024 1611.10	WM mini Back 4-16 1x1-10	0	4	0	0	2	0	0	160x40	0.74	1.631
71 2024 1612.01	WM mini Back 4-16 1x2-32	0	16	0	0	0	0	0	2x(160x40)	1.30	2.866
71 2024 1612.02	WM mini Back 4-16 1x2-20	0	8	0	0	4	0	0	2x(160x40)	1.30	2.866
71 2024 1612.03	WM mini Back 4-16 1x2-14	0	4	0	0	6	0	0	2x(160x40)	1.30	2.866
71 2024 1612.04	WM mini Back 4-16 1x2-8	0	0	0	0	8	0	0	2x(160x40)	1.30	2.866
71 2024 1612.05	WM mini Back 4-16 1x2-11	0	0	8	1	0	2	0	2x(160x40)	1.30	2.866
71 2024 1612.06	WM mini Back 4-16 1x2-16	0	4	8	0	0	0	0	2x(160x40)	1.30	2.866
71 2024 1612.07	WM mini Back 4-16 1x2-26	0	12	0	0	2	0	0	2x(160x40)	1.30	2.866
71 2024 1612.08	WM mini Back 4-16 1x2-60	20	0	0	0	0	2	0	2x(160x40)	1.30	2.866

WMC series

CODE CODICE	ARTICLE ARTICOLO	MODULES COMBINATIONS COMBINAZIONE MODULI							PACKING SPACES mm	WEIGHT PESO	
		WMC 15w40 (2.5-11.5) mm	WMC 20w40 (4-16.5) mm	WMC 30w40 (10-25) mm	WMC 40 (21.5-34.5) mm	WMC 40 10-34	WMS 10x40	WMS 5x40		kg	lb
71 2024 1612.09	WM mini Back 4-16 1x2-19	0	7	3	0	2	1	0	2x(160x40)	1.30	2.866
71 2024 1612.10	WM mini Back 4-16 1x2-18	0	6	4	0	2	0	0	2x(160x40)	1.30	2.866
71 2024 1612.11	WM mini Back 4-16 1x2-38	8	6	0	0	2	0	0	2x(160x40)	1.30	2.866
71 2024 1612.12	WM mini Back 4-16 1x2-10	0	0	10	0	0	2	0	2x(160x40)	1.30	2.866
71 2024 1612.13	WM mini Back 4-16 1x2-17	0	6	0	0	5	0	0	2x(160x40)	1.30	2.866

WMC series

CODE CODICE	ARTICLE ARTICOLO	PACKING SPACE SPAZIO DI RIEMPIMENTO mm	WMC 50 (28-44) mm	WMC 50 10-44	PESO WEIGHT	
					kg	lb
71 2024 1511.01	WM mini Back 5-15 1x1-3	150x50	3	0	0.81	1.785
71 2024 1511.02	WM mini Back 5-15 1x1-3	150x50	0	3	0.81	1.785
71 2024 1512.01	WM mini Back 5-15 1x2-6	2x(150x50)	0	6	1.71	3.770
71 2024 1512.02	WM mini Back 5-15 1x2-6	2x(150x50)	6	0	1.71	3.770

Plastic Frames

WallMax® Plastic Frames

WallMax® Plastic Frames are a family of lightweight mounting solutions made of glass-fibre reinforced plastic. Light Frames are specifically designed for applications where weight containment is essential, for instance where the wall supporting the installation is light in construction and has low bearing capacity. Each lightweight WallMax® frame has different characteristics, whose combination offers a wide variety of uses and applications, especially inside cabinets, data centers, and for the automation sector. Plastic Frames are designed for installation through bolting.

Cornici Plastiche WallMax®

Le Cornici Plastiche WallMax® sono soluzioni di montaggio in materiale plastico rinforzato con fibre di vetro. Le cornici leggere sono sviluppate per installazioni in cui è essenziale fornire una sigillatura efficace limitando il peso della soluzione di montaggio, ad esempio all'interno di cabinet dove la parete di supporto non può reggere il peso di cornici di metallo. Le Cornici Plastiche sono soluzioni di montaggio destinate all'installazione attraverso imbullonatura.



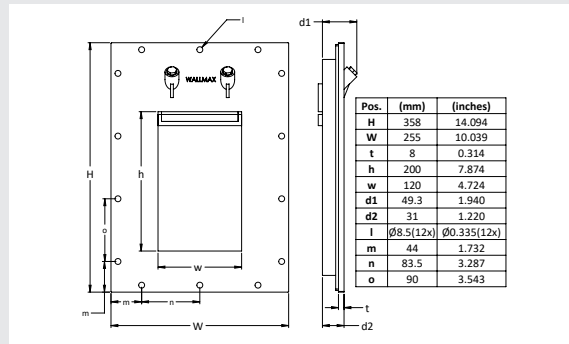
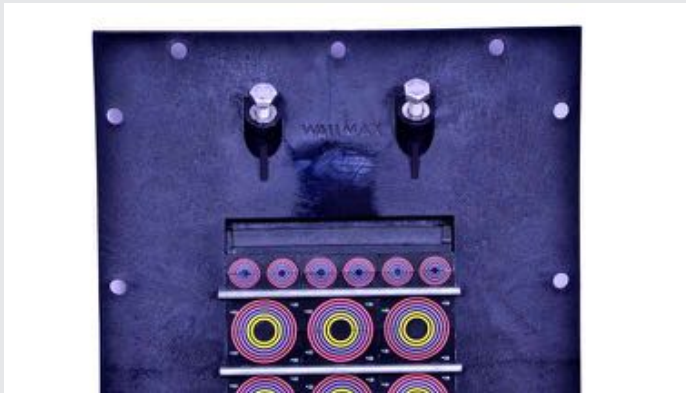

MATERIALS	MATERIALE
PA 6.6 30% Glass Filled	Plastica 6.6 rinforzata con 30% di fibre di vetro

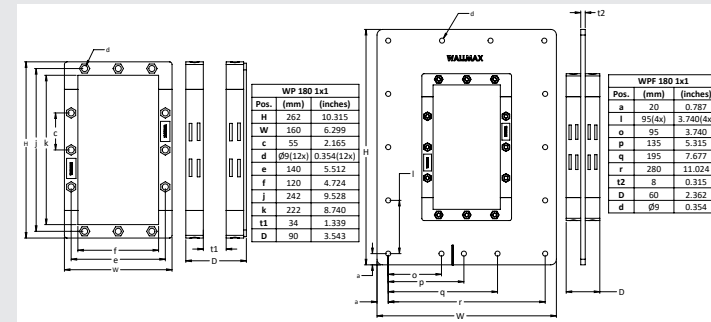

MATERIAL	MATERIALE
PA 6.6 30% Glass Filled	Plastica 6.6 rinforzata con 30% di fibre di vetro

WCC PA WallMax® Combined Compact Frame

WallMax® Combined Compact is a flanged frame with an integrated compression unit, designed for installations especially in telecom shelters, control panels, enclosures. WCC PA holds the same functionalities of the mini series, while allowing for sealing solutions comprising of a larger number of modules, and supporting mounting of cables with wider diameters.

WCC PA Cornice Combinata Compatta WallMax®

La Cornice Combinata Compatta WallMax® è un telaio flangiato con unità di compressione integrata, pensato per installazioni all'interno di cabinet e pannelli di controllo. Il telaio WCC PA presenta le stesse funzionalità dei prodotti della serie mini, ma supporta installazioni con un elevato numero di passaggi cavo e permette di sigillare cavi e tubi di grandi dimensioni.

WM PA WallMax® Modular Plastic Regular Frame & WMF PA WallMax® Plastic Regular Modular Frame with Flange

WallMax® Frames Modular Plastic Regular and Plastic Regular Modular with Flange are designed for installation in lightweight applications, in combination with modules and accessories of the WMR series. WM PA & WMF PA solutions are designed for installation where cables/pipes are already in place and it is not feasible to cut them and re-installed them.

WM PA Cornice Standard Modulare in Plastica WallMax® & WMF PA Cornice Standard Modulare in Plastica con Flangia WallMax®

Le cornici standard modulari e standard modulari con flangia sono pensate per applicazioni dove il contenimento del peso è essenziale. Sono da utilizzare in combinazione con i moduli e gli accessori della gamma WMR. Le cornici WM PA & WMF PA sono pensati per soluzioni di installazione dove sono già presenti dei cavi o tubi e il cliente vuole evitare di tagliarli e di conseguenza rigiuntarli.

To be used in combination with/utilizzate in combinazione con

WMC series						
CODE	ARTICLE	PACKING SPACE	EXTERNAL DIMENSIONS		PESO	
CODICE	ARTICOLO	SPAZIO DI RIEMPIMENTO	DIMENSIONI ESTERNE		WEIGHT	
		mm	mm	in	kg	lb
71 1326 1811	WCC PA	180x120	358x255	14.094x10.039	1.50	3.309

To be used in combination with/utilizzate in combinazione con

WMR series						
CODE	ARTICLE	OPENINGS	PACKING SPACE	EXTERNAL DIMENSIONS		PESO
CODICE	ARTICOLO	APERTURE TELAIO	SPAZIO DI RIEMPIMENTO	DIMENSIONI ESTERNE		WEIGHT
			mm	HxW (D=60mm)	mm	in
					kg	lb
71 1606 1811	WM PA	1x1	180x120	262x160	10.315x6.299	1.20 2.643
71 1616 1811	WMF PA 1x1	1x1	180x120	420x320	16.535x12.598	2.50 5.505
71 1616 1812	WMF PA 1x2	1x2	2x(180x120)	420x570	16.535x22.440	4.74 10.441

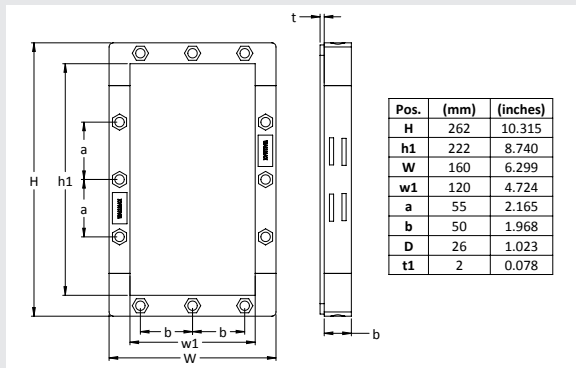

MATERIALS	MATERIALI
PA 6.6 30% Glass Filled	Plastica 6.6 rinforzata con 30% di fibre di vetro

WX 200 PA WallMax® Plastic Extra Compact Frame

WX 200 PA Cornice Compatta Extra WallMax®

WX 200 PA is a versatile modular frame that can be mounted around existing installations. Mounting of the frame, and at the same time compression of the sealing solution, is achieved through bolts, without the use of an expander. WX 200 PA thus offers additional packing space for cable passages.

La cornice compatta extra WallMax® è un telaio modulare adatto all'installazione attorno a passaggi a muro già esistenti. La compressione della cornice avviene attraverso bulloni, che permettono di sigillare il passaggio cavi senza bisogno di utilizzare un'unità di compressione separata. La cornice WX 200 PA offre dunque un maggiore spazio di riempimento e permette l'installazione di un più elevato numero di cavi in un'unica soluzione.

To be used in combination with/utilizzate in combinazione con

WMC series		OPENINGS APERTURE TELAIO	PACKING SPACE SPAZIO DI RIEMPIMENTO	EXTERNAL DIMENSIONS DIMENSIONI ESTERNE HxW (D=30mm)		PESO WEIGHT	
CODE CODICE	ARTICLE ARTICOLO			mm	mm	in	kg
71 1306 2011	WX 200 PA	1x1	220x120	262x160	10.315x6.299	0.61	1.334

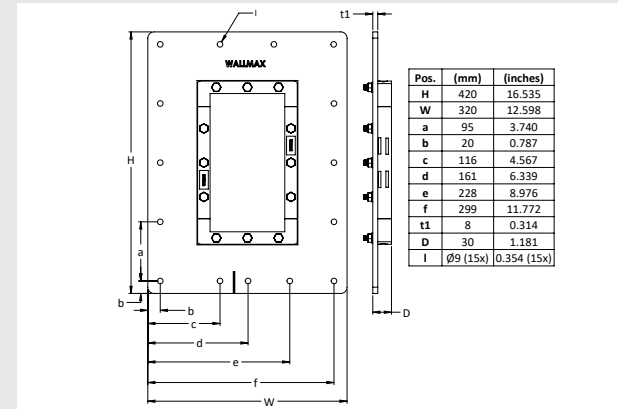
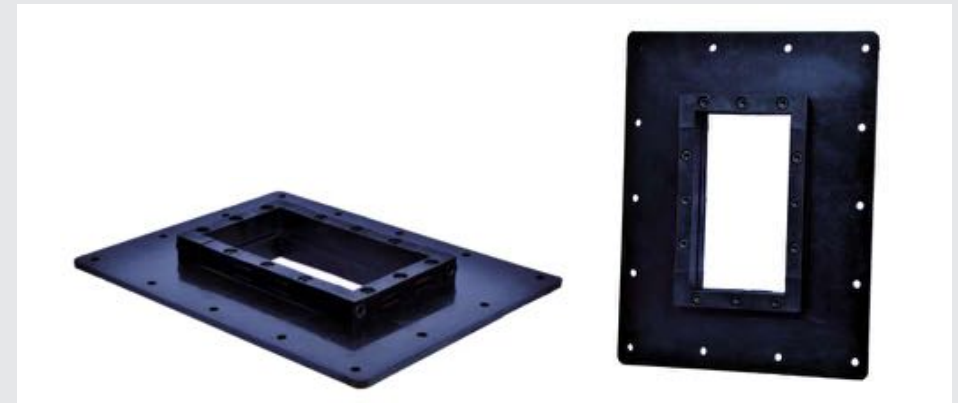

MATERIALS	MATERIALI
PA 6.6 30% Glass Filled	Plastica 6.6 rinforzata con 30% di fibre di vetro

WMFC PA WallMax® Modular Frame Compact PA

WMFC PA Cornice Modulare Compatta PA WallMax®

WMFC PA is a flanged solution that allows sealing of cable passages and providing extra versatility in terms of module combinations. WMFC PA solutions are designed for installation where cables/pipes are already in place and it is not feasible to cut them and re-installed them.

La cornice WMFC è un telaio flangiato che permette di sigillare il passaggio cavi e offre la possibilità di creare diverse combinazioni di moduli. Le cornici WMFC PA sono pensate per soluzioni di installazione dove sono già presenti dei cavi o tubi e il cliente vuole evitare di tagliarli e di conseguenza rigiuntarli.

To be used in combination with/utilizzate in combinazione con

WMC series		OPENINGS APERTURE TELAIO	PACKING SPACE SPAZIO DI RIEMPIMENTO	EXTERNAL DIMENSIONS DIMENSIONI ESTERNE HxW (D=30mm)		PESO WEIGHT	
CODE CODICE	ARTICLE ARTICOLO			mm	mm	in	kg
71 1316 1811	WMFC PA	1x1	180x120	420x 320	16.535x12.598	1.78	3.924

WR

WallMax® Round Frame

WallMax® Round Frame

WallMax® Round frames are designed specifically as pipe transit solutions. The two-part structure is pre-assembled with a special, single-opening round module that accommodates and seals the passage of one pipe only, each model with a different range of diameter openings.

WR frames can be completed with sleeves to secure pipe passages, where bolts on the frontal flange allow to seal the path of the pipe.

Sleeves are sold as accessories and are available for each size of the WR.

Cornice Circolare WallMax®

Le Cornici Circolari WR sono soluzioni specifiche per il passaggio di tubi. Ogni cornice è composta da due metà, assemblate attorno a uno speciale modulo rotondo ad apertura singola che consente l'ingresso di un unico tubo.

Ogni modello può sigillare uno spettro di diametri diversi.

I modelli WR possono essere completati con manicotti esterni per assicurare ulteriormente la soluzione di montaggio.

I bulloni della flangia frontale si stringono per sigillare il passaggio del tubo.

I manicotti sono disponibili per tutte le diverse dimensioni di WR.



WallMax® Round Frame

The different sizes of WR allow for securing passages of the widest possible range of cable and pipe diameters.
Each round rubber module has been designed to fit vast dimensions of pipes, through the easy-to-use peel-off inner layers.

Comice Circolare WallMax®

Le diverse dimensioni dei modelli WR permettono di sigillare il passaggio di tubi e cavi di dimensioni differenti.
Ogni modulo di gomma è progettato per adattarsi a una vasta gamma di diametri, grazie alla tecnologia a strati di facile utilizzo.

MATERIALS	MATERIALI
SS AISI 316	Acciaio inox resistente agli acidi
Other materials available upon request	Disponibile in altri materiali su richiesta

DATASHEET PAGE: 160

WR		FOR CABLES AND PIPES		WALL OPENING		WEIGHT	
CODE	ARTICLE	PER CAVI O TUBI DI DIAMETRO		APERTURA FORO		PESO	
CODICE	ARTICOLO	øA-øB (mm)	øA-øB (in)	øA-øB (mm)	øA-øB (in)	kg	lb
71 1111 0023	WR 23 AISI 316	0+ 3.6-11.0	0+ 0.142-0.450	24-25	0.945-0.984	0.05	0.110
71 1111 0025	WR 25 AISI 316	0+ 3.6-12.0	0+ 0.142-0.472	26-27	1.023-1.062	0.06	0.137
71 1111 0031	WR 31 AISI 316	0+ 4.0-17.0	0+ 0.157-0.669	32-33	1.259-1.299	0.08	0.174
71 1111 0043	WR 43 AISI 316	0+ 4.0-23.0	0+ 0.157-0.906	43-44	1.693-1.732	0.26	0.575
71 1111 0050	WR 50 AISI 316	0+ 8.0-30.0	0+ 0.315-1.181	50-51	1.967-2.008	0.28	0.608
71 1111 0068	WR 68 AISI 316	0+ 24.0-48.0	0+ 0.945-1.890	68-69	2.677-2.716	0.47	1.030
71 1111 0075	WR 75 AISI 316	0+ 24.0-54.0	0+ 0.945-2.126	75-76	2.953-2.992	0.49	1.071
71 1111 0078	WR 78 AISI 316	0+ 24.0-54.0	0+ 0.945-2.126	79-80	3.110-3.149	0.62	1.376
71 1111 0100	WR 100 AISI 316	0+ 48.0-70.0	0+ 1.890-2.756	100-101	3.937-3.976	0.98	2.167
71 1111 0125	WR 125 AISI 316	0+ 68.0-98.0	0+ 2.677-3.858	125-126	4.921-4.961	1.34	2.963
71 1111 0150	WR 150 AISI 316	0+ 93.0-119.0	0+ 3.661-4.685	150-151	5.906-5.945	1.51	3.325
71 1111 0175	WR 175 AISI 316	0+ 119.0-145.0	0+ 4.685-5.708	176-177	6.929-6.969	2.52	5.56
71 1211 0100	WR 100 wop AISI 316	48.0-70.0	1.890-2.756	100-101	3.937-3.976	0.86	1.885
71 1211 0125	WR 125 wop AISI 316	68.0-98.0	2.677-3.858	125-126	4.921-4.961	1.10	2.427
71 1211 0150	WR 150 wop AISI 316	93.0-119.0	3.661-4.685	150-151	5.906-5.945	1.26	2.787

WR

CODE	ARTICLE	FOR CABLES AND PIPES		WALL OPENING		WEIGHT	
CODICE	ARTICOLO	PER CAVI O TUBI DI DIAMETRO		APERTURA FORO		PESO	
		øA-øB (mm)	øA-øB (in)	øA-øB (mm)	øA-øB (in)	kg	lb
71 1211 0175	WR 175 wop AISI 316	119.0-145.0	4.685-5.708	176-177	6.929-6.969	1.73	3.503
71 1211 0200	WR 200 wop AISI 316	138.0-170.0	5.430-6.690	201-202	7.913-7.952	2.01	4.427

NOTE: Weights are approximate.
NOTE: I pesi dichiarati sono indicativi.

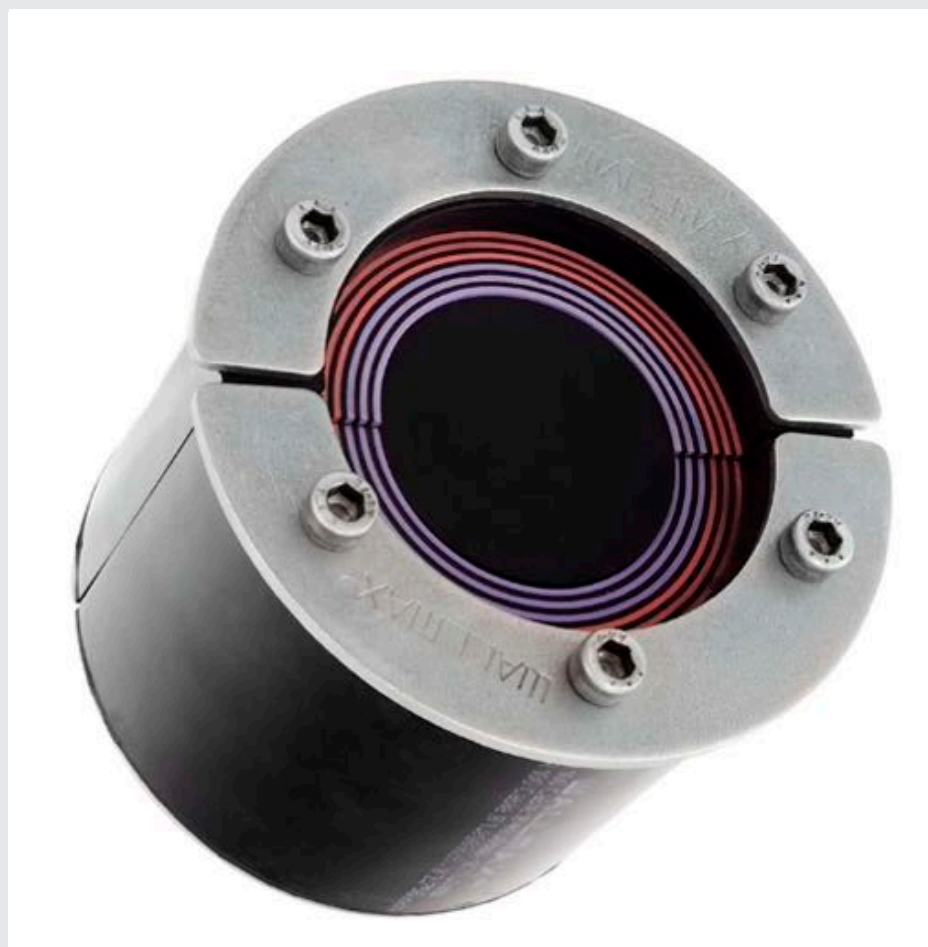

SLVWR

WALLMAX®
PRODUCT CATALOGUE

Sleeve

Sleeves are accessories and complements to WR frames.

Useful tools to secure passages and mount frames according to customer's needs, they come in different sizes and materials, to fit any model of WR.

SLVWR are designed for installation through casting in the wall or welding.

DATASHEET PAGE: 161

Manicotto

I Manicotti sono accessori complementari alle cornici WR.

Utilizzabili per assicurare il passaggio di cavi e tubi e installare le cornici in base alle necessità del cliente, sono disponibili in dimensioni e materiali diversi, per adattarsi ad ogni modello di WR.

I SLVWR sono soluzioni di montaggio destinate all'installazione attraverso saldatura o muratura.



MATERIALS	MATERIALI
Primed Steel	Acciaio con prima mano antiruggine
SS AISI 316 L	Acciaio inox resistente agli acidi
Aluminium	Alluminio
Galvanized Steel	Acciaio galvanizzato
Other materials available upon request	Disponibile in altri materiali su richiesta

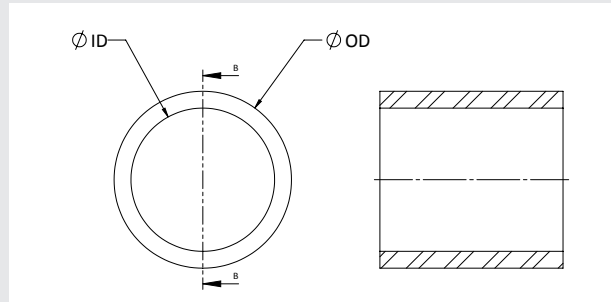

WR

CODE	ARTICLE	ø D INNER	ø D OUTER	WEIGHT	
CODICE	ARTICOLO	DIAMETRO INTERNO	DIAMETRO ESTERNO	PESO	
		mm	mm	kg	lb
71 1130 0023	SLVWR 23 Primed	24	32	0.08	0.181
71 1130 0025	SLVWR 25 Primed	26	34	0.09	0.194
71 1130 0031	SLVWR 31 Primed	32	40	0.11	0.234
71 1130 0043	SLVWR 43 Primed	44	52	0.31	0.675
71 1130 0050	SLVWR 50 Primed	51	63	0.55	1.202
71 1130 0068	SLVWR 68 Primed	69.5	83	0.85	1.867
71 1130 0075	SLVWR 75 Primed	76.5	89	0.85	1.882
71 1130 0078	SLVWR 78 Primed	79	93	0.89	1.962
71 1130 0100	SLVWR 100 Primed	101	114	1.11	2.454
71 1130 0125	SLVWR 125 Primed	126	140	1.48	3.269
71 1130 0150	SLVWR 150 Primed	151	164	1.63	3.596
71 1130 0175	SLVWR 175 Primed	176	190	2.04	4.490
71 1130 0200	SLVWR 200 Primed	201	214	2.15	4.736
71 1131 0023	SLVWR 23 AISI 316	24	32	0.09	0.187
71 1131 0025	SLVWR 25 AISI 316	26	34	0.09	0.200
71 1131 0031	SLVWR 31 AISI 316	32	40	0.11	0.240
71 1131 0043	SLVWR 43 AISI 316	44	52	0.32	0.694

SLVWR

WALLMAX®
PRODUCT CATALOGUE

WR

CODE	ARTICLE	ø D INNER	ø D OUTER	WEIGHT	
CODICE	ARTICOLO	DIAMETRO INTERNO	DIAMETRO ESTERNO	PESO	
		mm	mm	kg	lb
71 1131 0050	SLVWR 50 AISI 316	51	63	0.56	1.237
71 1131 0068	SLVWR 68 AISI 316	69.5	83	0.87	1.922
71 1131 0075	SLVWR 75 AISI 316	76.5	89	0.88	1.938
71 1131 0078	SLVWR 78 AISI 316	79	93	0.89	1.962
71 1131 0100	SLVWR 100 AISI 316	101	114	1.15	2.524
71 1131 0125	SLVWR 125 AISI 316	126	140	1.53	3.364
71 1131 0150	SLVWR 150 AISI 316	151	164	1.68	3.699
71 1131 0175	SLVWR 175 AISI 316	176	190	2.10	4.620
71 1131 0200	SLVWR 200 AISI 316	201	214	2.21	4.874
71 1132 0023	SLVWR 23 AL	24	32	0.03	0.064
71 1132 0025	SLVWR 25 AL	26	34	0.03	0.068
71 1132 0031	SLVWR 31 AL	32	40	0.04	0.082
71 1132 0043	SLVWR 43 AL	44	52	0.11	0.234
71 1132 0050	SLVWR 50 AL	51	63	0.19	0.417
71 1132 0068	SLVWR 68 AL	69.5	83	0.29	0.646
71 1132 0075	SLVWR 75 AL	76.5	89	0.30	0.653
71 1132 0078	SLVWR 78 AL	79	93	0.31	0.683
71 1132 0100	SLVWR 100 AL	101	114	0.39	0.849
71 1132 0125	SLVWR 125 AL	126	140	0.51	1.131
71 1132 0150	SLVWR 150 AL	151	164	0.56	1.243
71 1132 0175	SLVWR 175 AL	176	190	0.71	1.560
71 1132 0200	SLVWR 200 AL	201	214	0.86	1.896
71 1133 0023	SLVWR 23 Galv	24	32	0.08	0.181
71 1133 0025	SLVWR 25 Galv	26	34	0.09	0.194
71 1133 0043	SLVWR 43 Galv	44	52	0.31	0.675
71 1133 0050	SLVWR 50 Galv	51	63	0.55	1.202
71 1133 0068	SLVWR 68 Galv	69.5	83	0.85	1.867
71 1133 0075	SLVWR 75 Galv	76.5	89	0.85	1.882
71 1133 0078	SLVWR 78 Galv	79	93	0.86	1.962
71 1133 0100	SLVWR 100 Galv	101	114	1.11	2.454
71 1133 0125	SLVWR 125 Galv	126	140	1.48	3.269
71 1133 0150	SLVWR 150 Galv	151	164	1.63	3.596
71 1133 0175	SLVWR 175 Galv	176	190	2.04	4.490
71 1133 0200	SLVWR 200 Galv	201	214	0.74	1.640

SLVFWR

Flanged Sleeve

Sleeves are accessories and complements to WR frames.

Useful tools to secure passages and mount frames according to customer needs, they come in different sizes and materials, to fit any model of WR.

SLVFWR are designed for installation through bolting.

DATASHEET PAGE: 162

MATERIALS	MATERIALI
Primed Steel	Acciaio con prima mano antiruggine
SS AISI 316 L	Acciaio inox resistente agli acidi
Aluminium	Alluminio
Galvanized Steel	Acciaio galvanizzato
Other materials available upon request	Disponibile in altri materiali su richiesta

Manicotto Flangiato

I Manicotti Flangiati sono accessori complementari alle cornici WR.

Utilizzabili per assicurare il passaggio di cavi e tubi e installare le cornici in base alle necessità del cliente, sono disponibili in dimensioni e materiali, per adattarsi ad ogni modello di WR. I SLVFWR sono soluzioni di montaggio destinate all'installazione attraverso imbullonatura.

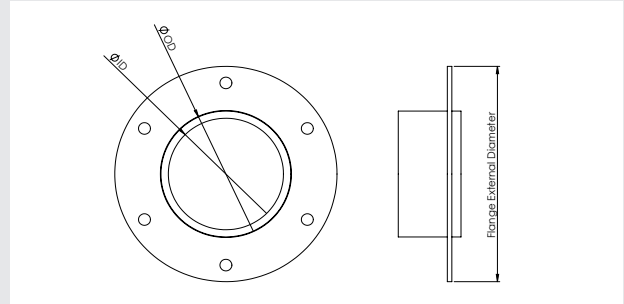

Note: Su richiesta, fornitura di flangia senza fori / Flange without holes upon request.

WR		ø D INNER	ø D OUTER	EXTERNAL DIAMETER FLANGE	WEIGHT	
CODE	ARTICLE	DIAMETRO INTERNO	DIAMETRO ESTERNO	DIAMETRO ESTERNO FLANGIA	PESO	
CODICE	ARTICOLO	mm	mm	mm	kg	lb
71 1150 0023	SLVFWR 23 Primed	24	32	96	0.27	0.595
71 1150 0025	SLVFWR 25 Primed	26	34	96	0.29	0.635
71 1150 0031	SLVFWR 31 Primed	32	40	102	0.33	0.719
71 1150 0043	SLVFWR 43 Primed	44	52	110	0.52	1.153
71 1150 0050	SLVFWR 50 Primed	51	63	140	0.91	2.015
71 1150 0068	SLVFWR 68 Primed	69.5	83	155	1.25	2.760
71 1150 0075	SLVFWR 75 Primed	76.5	89	165	1.31	2.892
71 1150 0078	SLVFWR 78 Primed	79	93	168	1.35	2.976
71 1150 0100	SLVFWR 100 Primed	101	114	195	1.70	3.757
71 1150 0125	SLVFWR 125 Primed	126	140	213	2.09	4.610
71 1150 0150	SLVFWR 150 Primed	151	164	236	2.30	5.079
71 1150 0175	SLVFWR 175 Primed	176	190	255	2.73	6.019
71 1150 0200	SLVFWR 200 Primed	201	214	290	3.06	6.746
71 1151 0023	SLVFWR 23 AISI 316	24	32	96	0.28	0.617
71 1151 0025	SLVFWR 25 AISI 316	26	34	96	0.29	0.633
71 1151 0031	SLVFWR 31 AISI 316	32	40	102	0.32	0.703
71 1151 0043	SLVFWR 43 AISI 316	44	52	110	0.53	1.173
71 1151 0050	SLVFWR 50 AISI 316	51	63	140	0.93	2.050

SLVFWR

WR		ø D INNER	ø D OUTER	EXTERNAL DIAMETER FLANGE	WEIGHT	
CODE	ARTICLE	DIAMETRO INTERNO	DIAMETRO ESTERNO	DIAMETRO ESTERNO FLANGIA	PESO	
CODICE	ARTICOLO	mm	mm	mm	kg	lb
71 1151 0068	SLVFWR 68 AISI 316	69.5	83	155	1.28	2.815
71 1151 0075	SLVFWR 75 AISI 316	76.5	89	165	1.38	3.036
71 1151 0078	SLVFWR 78 AISI 316	79	93	168	1.35	2.976
71 1151 0100	SLVFWR 100 AISI 316	101	114	195	1.74	3.829
71 1151 0125	SLVFWR 125 AISI 316	126	140	213	2.13	4.705
71 1151 0150	SLVFWR 150 AISI 316	151	164	236	2.35	5.183
71 1151 0175	SLVFWR 175 AISI 316	176	190	255	2.80	6.172
71 1151 0200	SLVFWR 200 AISI 316	201	214	290	3.12	6.885
71 1152 0023	SLVFWR 23 AL	24	32	96	0.09	0.198
71 1152 0025	SLVFWR 25 AL	26	34	96	0.10	0.209
71 1152 0031	SLVFWR 31 AL	32	40	102	0.11	0.236
71 1152 0043	SLVFWR 43 AL	44	52	110	0.18	0.399
71 1152 0050	SLVFWR 50 AL	51	63	140	0.31	0.697
71 1152 0068	SLVFWR 68 AL	69.5	83	155	0.43	0.957
71 1152 0075	SLVFWR 75 AL	76.5	89	165	0.45	1.001
71 1152 0078	SLVFWR 78 AL	79	93	168	0.46	1.014
71 1152 0100	SLVFWR 100 AL	101	114	195	0.59	1.301
71 1152 0125	SLVFWR 125 AL	126	140	213	0.72	1.596
71 1152 0150	SLVFWR 150 AL	151	164	236	0.80	1.759
71 1152 0200	SLVFWR 175 AL	176	190	255	0.95	2.094
71 1152 0200	SLVFWR 200 AL	201	214	290	1.06	2.335
71 1153 0023	SLVFWR 23 Galv	24	32	96	0.27	0.595
71 1153 0025	SLVFWR 25 Galv	26	34	96	0.29	0.635
71 1153 0031	SLVFWR 31 Galv	32	40	102	0.33	0.719
71 1153 0043	SLVFWR 43 Galv	44	52	110	0.52	1.153
71 1153 0050	SLVFWR 50 Galv	51	63	140	0.91	2.015
71 1153 0068	SLVFWR 68 Galv	69.5	83	155	1.25	2.760
71 1153 0075	SLVFWR 75 Galv	76.5	89	165	1.31	2.892
71 1153 0078	SLVFWR 78 Galv	79	93	168	1.35	2.976
71 1153 0100	SLVFWR 100 Galv	101	114	195	1.70	3.757
71 1153 0125	SLVFWR 125 Galv	126	140	213	2.09	4.610
71 1153 0150	SLVFWR 150 Galv	151	164	236	2.30	5.079
71 1153 0175	SLVFWR 175 Galv	176	190	255	2.73	6.019
71 1153 0200	SLVFWR 200 Galv	201	214	290	3.06	6.746

WRS

WallMax® Round Squared Frame

WallMax® Round Squared Frame

WallMax® Round Squared frames are round structures with an inner, squared packing space that accommodates modules of the WMR series.

Multiple dimensions of packing space are offered to allow for maximum variety in module combination and maximum adaptability.

Sealing of passages is obtained through tightening of the bolts on the flange, with no need for use of an expander or retainer plates.

WRS frames can be completed and mounted with an additional external sleeve, which is sold separately as an accessory.

Cornice Circolare con Apertura Quadrata WallMax®

Le Cornici Circolari con Apertura Quadrata sono strutture di metallo rotonde con uno spazio di riempimento centrale squadrato, progettato per essere completato con combinazioni di moduli WMR.

Diverse dimensioni di spazio di riempimento sono disponibili per permettere la massima varietà nelle combinazioni di moduli e la massima flessibilità di utilizzo.

La sigillatura del punto d'ingresso si ottiene stringendo i bulloni della flangia frontale, senza necessità di utilizzo di un'unità di compressione.

Le cornici WRS possono essere montate anche con l'aggiunta di un manicotto esterno, venduto come accessorio separato.

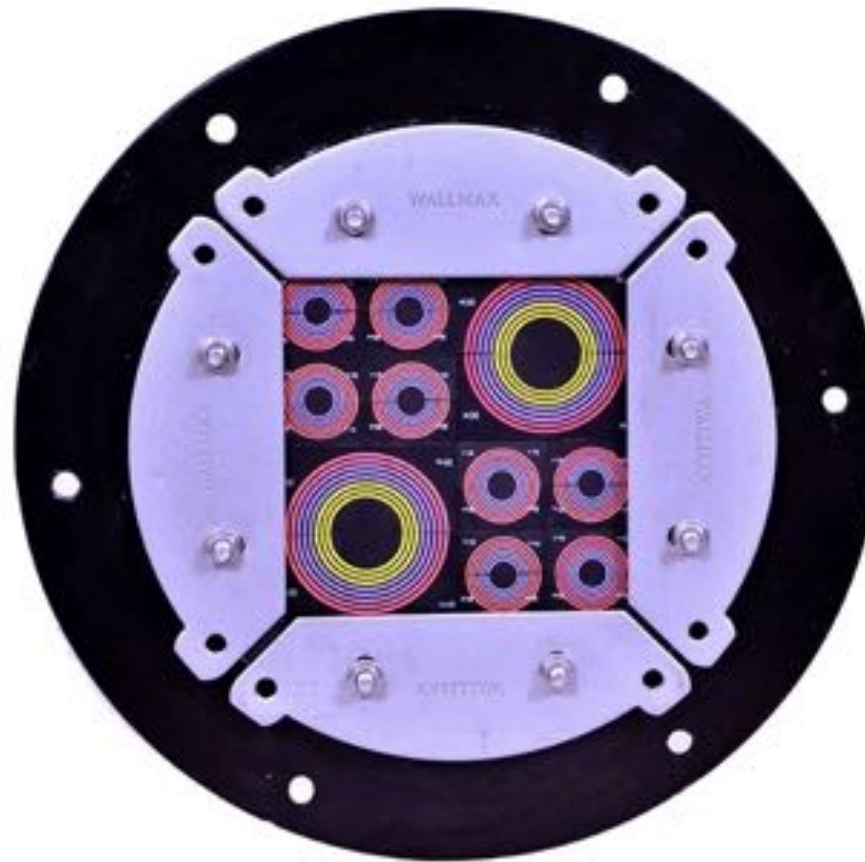

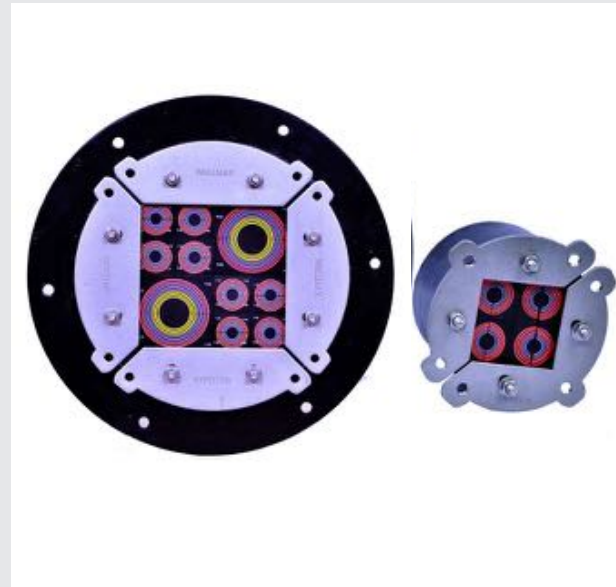

WallMax® Round Squared Frame

The WRS frames are available in different materials and allow for customization of entry solutions.

Comice Circolare con Apertura Quadrata WallMax®

Le cornici WRS sono disponibili in diversi materiali e con combinazioni di moduli diverse e personalizzabili.

MATERIALS	MATERIALI
SS AISI 316	Acciaio inox resistente agli acidi
Galvanized Steel with powder coat finishing	Acciaio galvanizzato ricoperto da prima mano di vernice
Other materials available upon request	Disponibile in altri materiali su richiesta

DATASHEET PAGE: 163

To be used in combination with/utilizzate in combinazione con

WMR series		WALL OPENING APERTURA FORO		PACKING SPACE SPAZIO DI RIEMPIMENTO	WEIGHT PESO	
CODE CODICE	ARTICLE ARTICOLO	øA-øB (mm)	øA-øB (in)	mm	kg	lb
71 1101 0070	WRS 70 AISI 316	71-72	2.795-2.834	40x40	0.43	0.952
71 1101 0075	WRS 75 AISI 316	76-77	2.992-3.031	40x40	0.49	1.076
71 1101 0100	WRS 100 AISI 316	101-102	3.976-4.016	60x60	0.72	1.581
71 1101 0125	WRS 125 AISI 316	126-127	4.961-5.000	80x80	1.04	2.282
71 1101 0127	WRS 127 AISI 316	128-129	5.039-5.078	80x80	1.07	2.350
71 1101 0150	WRS 150 AISI 316	151-152	5.945-5.984	90x90	1.50	3.316
71 1101 0200	WRS 200 AISI 316	201-202	7.913-7.953	120x120	2.48	5.459
71 1103 0070	WRS 70 Galv	71-72	2.795-2.834	40x40	0.43	0.939
71 1103 0075	WRS 75 Galv	76-77	2.992-3.031	40x40	0.48	1.065
71 1103 0100	WRS 100 Galv	101-102	3.976-4.016	60x60	0.71	1.554
71 1103 0125	WRS 125 Galv	126-127	4.961-5.000	80x80	1.02	2.253

WMR series		WALL OPENING APERTURA FORO		PACKING SPACE SPAZIO DI RIEMPIMENTO	WEIGHT PESO	
CODE CODICE	ARTICLE ARTICOLO	øA-øB (mm)	øA-øB (in)	mm	kg	lb
71 1103 0127	WRS 127 Galv	126-127	5.039-5.078	80x80	1.05	2.321
71 1103 0150	WRS 150 Galv	151-152	5.945-5.984	90x90	1.48	3.272
71 1103 0200	WRS 200 Galv	201-202	7.913-7.953	120x120	2.45	5.393

NOTE: Weights are approximate.
NOTA: I pesi dichiarati sono indicativi.



Sleeve

Sleeves are accessories and complements to WRS frames.
Useful tools to secure passages and mount frames according to customer's needs, they come in different sizes and materials, to fit any model of WRS.
SLVWRS are designed for installation through casting in the wall or welding.

Manicotto

I Manicotti sono accessori complementari alle cornici WRS.
Utilizzabili per assicurare il passaggio di cavi e tubi e installare le cornici in base alle necessità del cliente, sono disponibili in dimensioni e materiali diversi, per adattarsi ad ogni modello di WRS.
I SLVWRS sono soluzioni di montaggio destinate all'installazione attraverso saldatura o muratura.



MATERIALS	MATERIALI
Primed Steel	Acciaio con prima mano antiruggine
SS AISI 316 L	Acciaio inox resistente agli acidi
Aluminium	Alluminio
Galvanized Steel	Acciaio galvanizzato
Other materials available upon request	Disponibile in altri materiali su richiesta

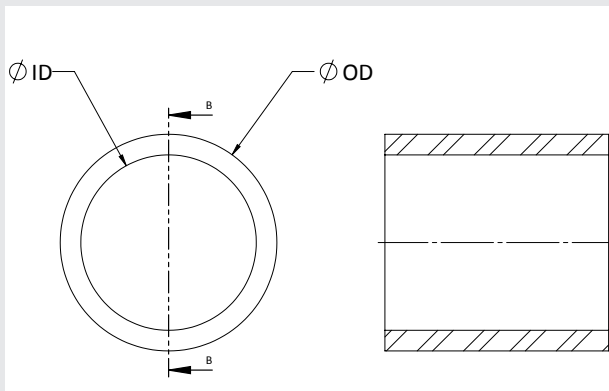

WRS		ø D INNER DIAMETRO INTERNO	ø D OUTER DIAMETRO ESTERNO	WEIGHT PESO	
CODE CODICE	ARTICLE ARTICOLO			kg	lb
71 1120 0070	SLVWRS 70 Primed	71	83	0.62	1.373
71 1120 0075	SLVWRS 75 Primed	76.5	89	0.72	1.594
71 1120 0100	SLVWRS 100 Primed	101	114	0.94	2.077
71 1120 0125	SLVWRS 125 Primed	126	140	1.26	2.767
71 1120 0127	SLVWRS 127 Primed	128	140	1.08	2.390
71 1120 0150	SLVWRS 150 Primed	151	164	1.38	3.042
71 1120 0200	SLVWRS 200 Primed	201	214	1.82	4.008

WRS		ø D INNER DIAMETRO INTERNO	ø D OUTER DIAMETRO ESTERNO	WEIGHT PESO	
CODE CODICE	ARTICLE ARTICOLO			kg	lb
71 1121 0070	SLVWRS 70 AISI 316	71	83	0.64	1.409
71 1121 0075	SLVWRS 75 AISI 316	76.5	89	0.74	1.640
71 1120 0070	SLVWRS 70 Primed	71	83	0.62	1.373
71 1120 0075	SLVWRS 75 Primed	76.5	89	0.72	1.594
71 1120 0100	SLVWRS 100 Primed	101	114	0.94	2.077
71 1120 0125	SLVWRS 125 Primed	126	140	1.26	2.767
71 1120 0127	SLVWRS 127 Primed	128	140	1.08	2.390
71 1120 0150	SLVWRS 150 Primed	151	164	1.38	3.042
71 1120 0200	SLVWRS 200 Primed	201	214	1.82	4.008
71 1121 0070	SLVWRS 70 AISI 316	71	83	0.64	1.409
71 1121 0075	SLVWRS 75 AISI 316	76.5	89	0.74	1.640
71 1121 0100	SLVWRS 100 AISI 316	101	114	0.70	1.534
71 1121 0125	SLVWRS 125 AISI 316	126	140	1.29	2.846
71 1121 0127	SLVWRS 127 AISI 316	128	140	1.11	2.449
71 1121 0150	SLVWRS 150 AISI 316	151	164	1.42	3.131
71 1121 0200	SLVWRS 200 AISI 316	201	214	1.87	4.125
71 1122 0070	SLVWRS 70 AL	71	83	0.22	0.476
71 1122 0075	SLVWRS 75 AL	76.5	89	0.25	0.551
71 1122 0100	SLVWRS 100 AL	101	114	0.33	0.719
71 1122 0125	SLVWRS 125 AL	126	140	0.43	0.957
71 1122 0127	SLVWRS 127 AL	128	140	0.38	0.827
71 1122 0150	SLVWRS 150 AL	151	164	0.48	1.054
71 1122 0200	SLVWRS 200 AL	201	214	0.63	1.387
71 1123 0070	SLVWRS 70 Galv	71	83	0.62	1.373
71 1123 0075	SLVWRS 75 Galv	76.5	89	0.72	1.594
71 1123 0100	SLVWRS 100 Galv	101	114	0.94	2.077
71 1123 0125	SLVWRS 125 Galv	126	140	1.26	2.767
71 1123 0125	SLVWRS 127 Galv	128	140	1.08	2.390
71 1123 0150	SLVWRS 150 Galv	151	164	1.38	3.042
71 1123 0200	SLVWRS 200 Galv	201	214	1.82	4.008

Flanged Sleeve

Sleeves are accessories and complements to WRS frames.

Useful tools to secure passages and mount frames according to customer's needs, they come in different sizes and materials, to fit any model of WRS.

SLVFWRS are designed for installation through bolting.

Manicotto Flangiato

I Manicotti Flangiati sono accessori complementari alle cornici WRS.

Utilizzabili per assicurare il passaggio di cavi e tubi e installare le cornici in base alle necessità del cliente, sono disponibili in dimensioni e materiali diversi, per adattarsi ad ogni modello di WRS.

I SLVFWRS sono soluzioni di montaggio destinate all'installazione attraverso imbullonatura.

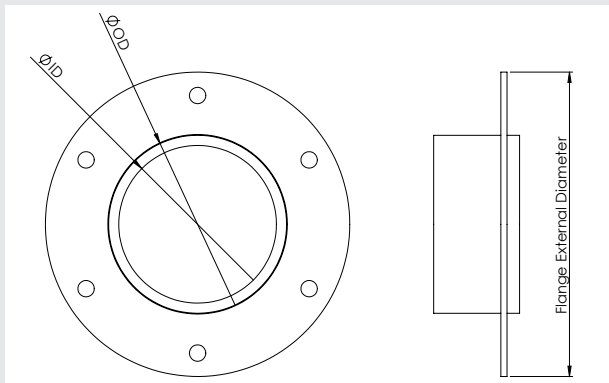

DATASHEET PAGE: 165

Note: Su richiesta, fornitura di flangia senza fori / Flange without holes upon request.

WRS		ø D INNER	ø D OUTER	EXTERNAL DIAMETER FLANGE	WEIGHT	
CODE	ARTICLE	DIAMETRO INTERNO	DIAMETRO ESTERNO	DIAMETRO ESTERNO FLANGIA	kg	lb
CODICE	ARTICOLO	mm	mm	mm		
71 1140 0070	SLVFWRS 70 Primed	71	83	160	0.84	1.852
71 1140 0075	SLVFWRS 75 Primed	76.5	89	165	1.18	2.604
71 1140 0100	SLVFWRS 100 Primed	101	114	195	1.53	3.380
71 1140 0125	SLVFWRS 125 Primed	126	140	213	1.86	4.107
71 1140 0127	SLVFWRS 127 Primed	128	140	213	1.88	4.151
71 1140 0150	SLVFWRS 150 Primed	151	164	236	2.05	4.526

WRS		ø D INNER	ø D OUTER	EXTERNAL DIAMETER FLANGE	WEIGHT	
CODE	ARTICLE	DIAMETRO INTERNO	DIAMETRO ESTERNO	DIAMETRO ESTERNO FLANGIA	kg	lb
CODICE	ARTICOLO	mm	mm	mm		
71 1140 0200	SLVFWRS 200 Primed	201	214	290	2.73	6.019
71 1141 0070	SLVFWRS 70 AISI 316	71	83	160	0.87	1.911
71 1141 0075	SLVFWRS 75 AISI 316	76.5	89	165	1.21	2.674
71 1141 0100	SLVFWRS 100 AISI 316	101	114	195	1.58	3.474
71 1141 0125	SLVFWRS 125 AISI 316	126	140	213	1.92	4.221
71 1141 0127	SLVFWRS 127 AISI 316	128	140	213	1.93	4.244
71 1141 0150	SLVFWRS 150 AISI 316	151	164	236	2.11	4.654
71 1141 0200	SLVFWRS 200 AISI 316	201	214	290	2.81	6.186
71 1142 0070	SLVFWRS 70 AL	71	83	160	0.29	0.633
71 1142 0075	SLVFWRS 75 AL	76,5	89	165	0.41	0.902
71 1142 0100	SLVFWRS 100 AL	101	114	195	0.53	1.171
71 1142 0125	SLVFWRS 125 AL	126	140	213	0.65	1.422
71 1142 0127	SLVFWRS 127 AL	128	140	213	0.66	1.444
71 1142 0150	SLVFWRS 150 AL	151	164	236	0.71	1.567
71 1142 0200	SLVFWRS 200 AL	201	214	290	0.95	2.083
71 1143 0070	SLVFWRS 70 Galv	71	83	160	0.84	1.852
71 1143 0075	SLVFWRS 75 Galv	76.5	89	165	1.18	2.604
71 1143 0100	SLVFWRS 100 Galv	101	114	195	1.53	3.380
71 1143 0125	SLVFWRS 125 Galv	126	140	213	1.86	4.107
71 1143 0127	SLVFWRS 127 Galv	128	140	213	1.88	4.151
71 1143 0150	SLVFWRS 150 Galv	151	164	236	2.05	4.526
71 1143 0200	SLVFWRS 200 Galv	201	214	290	2.73	6.019

ACCESSORIES

Accessories

A vast range of accessories and necessary complements for frames and modules is made available for complete mounting solutions.

Expanders, retainer plates and lubricant are developed to ensure secure sealing of wall entries and perfect, tight fit of modules within frame packing space.

Accessori

Oltre ai moduli e alle cornici è disponibile una vasta gamma di accessori per completare al meglio le soluzioni di sigillatura WallMax®.

Unità di compressione, piastre di contenimento e lubrificante sono sviluppati per assicurare la perfetta sigillatura degli ingressi e la completa vestibilità dei moduli all'interno degli spazi di riempimento delle cornici.



ACCESSORIES

WallMax®
PRODUCT CATALOGUE

WE WallMax® Expander

WallMax® Expanders are designed to compress the chosen module combination into each packing space within a frame, tightly sealing cable and pipe entries against passage of external elements. Compression can be easily controlled through the frontal screw.

Modulo di compressione

WallMax®

I moduli di compressione WE sono sviluppati per comprimere le varie combinazioni di moduli all'interno delle cornici e assicurare la perfetta sigillatura dei punti d'ingresso di cavi e tubi, permettendo di salvaguardare gli stessi dagli agenti ambientali. La compressione può essere facilmente regolata attraverso le viti frontali dell'unità.

MATERIALS	MATERIALI
SS AISI 316 L	Acciaio inox resistente agli acidi
Galvanized Steel	Acciaio galvanizzato



To be used in combination with/utilizzati in combinazione con

WMR series

*Kit = no. 5 Retainer Plate + no. 1 Lubricant 25ml + no. 1 Expander
*Kit = n. 5 Piastre di contenimento + n. 1 Lubrificante 25ml + n. 1 Modulo di compressione

PICTURE DISEGNO	CODE CODICE	ARTICLE ARTICOLO	WIDTH	DEPTH	WEIGHT	
			LARGHEZZA	PROFONDITA'	kg	lb
	71 6011 0101	*WE 120 Kit AISI 316	120	60	1.45	3.197
	71 6021 0004	WE 40 AISI 316	40	60	0.20	0.441
	71 6021 0006	WE 60 AISI 316	60	60	0.40	0.882
	71 6021 0012	WE 120 AISI 316	120	60	0.80	1.764
	71 6013 0101	*WE 120 Kit Galv	120	60	1.45	3.197
	71 6023 0004	WE 40 Galv	40	60	0.20	0.441
	71 6023 0006	WE 60 Galv	60	60	0.40	0.882
	71 6023 0012	WE 120 Galv	120	60	0.80	1.764

WMC series

PICTURE DISEGNO	CODE CODICE	ARTICLE ARTICOLO	WIDTH	DEPTH	WEIGHT	
			LARGHEZZA	PROFONDITA'	kg	lb
	71 3021 0012	WEC 120 AISI 316	120	30	0.77	1.690
	71 3023 0012	WEC 120 Galv	120	30	0.77	1.690

WE-WRP-WMLUB-WPCT
ACCESSORIES

WallMax®
PRODUCT CATALOGUE

WRP

WallMax® Retainer Plate

WallMax® Retainer Plates are metal plaques used to compress and stabilize each layer of modules into the packing space of a frame. In combination with WEs, they help perfectly seal passages and protect entries from dust, fire, water and other elements.



PICTURE DISEGNO	CODE CODICE	ARTICLE ARTICOLO	WIDTH	DEPTH	WEIGHT	
			LARGHEZZA	PROFONDITA'	g	lb
	71 6041 0004	WRP 40 AISI 316	40	60	0.04	0.084
	71 6041 0006	WRP 60 AISI 316	60	60	0.06	0.126
	71 6041 0012	WRP 120 AISI 316	120	60	0.19	0.423
	71 3041 0012	WRPC 120 AISI 316	120	30	0.09	0.212
	71 6042 0004	WRP 40 AL	40	60	0.01	0.029
	71 6042 0006	WRP 60 AL	60	60	0.02	0.042
	71 6042 0012	WRP 120 AL	120	60	0.07	0.143
	71 3042 0012	WRPC 120 AL	120	30	0.04	0.072
	71 6043 0004	WRP 40 Galv	40	60	0.03	0.075
	71 6043 0006	WRP 60 Galv	60	60	0.05	0.119
	71 6043 0012	WRP 120 Galv	120	60	0.19	0.410
	71 3043 0012	WRPC 120 Galv	120	30	0.09	0.205

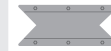

Piastra di Contenimento

Le piastre di contenimento sono placche di metallo utilizzate per comprimere e consolidare ogni strato di moduli all'interno dello spazio di riempimento di una cornice. Grazie anche alla compressione fornita dai WE, le piastre permettono di ottenere una perfetta sigillatura perfetta dei punti di ingresso e di bloccare il passaggio di elementi come polvere, acqua e fuoco.

MATERIALS	MATERIALI
SS AISI 316	Acciaio inox resistente agli acidi
Aluminium	Alluminio
Galvanized Steel	Acciaio galvanizzato
Other materials available upon request	Disponibile in altri materiali su richiesta

WPCT WallMax®

Pre-Compression Tool

WallMax® pre-compression tools are developed for use during module installation, to compress and hold modules and retainer plates into position and ease insertion of the WE Expander into frames.

Strumenti di

Precompressione WallMax®

Gli strumenti per la precompressione sono accessori sviluppati per comprimere e bloccare moduli e piastre di contenimento, così da facilitare l'installazione di tutti i componenti e l'inserimento dell'espansore WE all'interno della cornice.



CODE CODICE	ARTICLE ARTICOLO	DESCRIPTION DESCRIZIONE
71 7020 0001	WPCTL W 120	WallMax® Pre Compression Tool Long Width 120
71 7020 0002	WPCTS W 120	WallMax® Pre Compression Tool Short Width 120
71 7020 0003	WPCTL W 60	WallMax® Pre Compression Tool Long Width 60
71 7020 0004	WPCTS W 60	WallMax® Pre Compression Tool Short Width 60

WMLub WallMax® Lube

WallMax® Lubricant is a useful accessory for assembling module halves and installing each complete module into frame space.
Two sizes and packages are available for purchase.



Lubrificante WallMax®

Il lubrificante WallMax® è un utile accessorio di assemblaggio per assicurare tra loro le due metà di ciascun modulo e per inserire i vari blocchetti all'interno dello spazio di riempimento.
Il lubrificante è disponibile in due formati.

WM Lub

PICTURE DISEGNO	CODE CODICE	ARTICLE ARTICOLO	QUANTITY QUANTITA'		WEIGHT PESO	
			ml	kg	lb	
	71 7001 0010	WMLub 10ml	10	0.03	0.066	
	71 7001 0025	WMLub 25ml	25	0.04	0.088	
	71 7002 0010	WMLubSil 10ml	10	0.01	0.020	
	71 7002 0025	WMLubSil 25ml	25	0.02	0.040	

NOTES:

WMLubSil - Silicon grease for WM mini R and plastic frames. Recommended for low pressure applications only, up to IP 65.

WMLub - Natural grease recommended for high pressure applications.

WMLubSil - Grasso silconico per WM mini R e Telai di plastica. Raccomandato per applicazioni a bassa pressione, fino a IP65.

WMLub - Grasso naturale raccomandato per applicazioni ad alta pressione.

WSS Sealing strip

WallMax® Sealing Strip is designed for use in combination with flanged frames to achieve perfect sealing.
It is sold in individual rolls, each 2m in length.

Nastro Isolante WSS

Il nastro isolante WSS è da utilizzare in combinazione con i telai flangiati WallMax® per ottenere la perfetta sigillatura dei passaggi a muro.
Viene venduto in rotoli di lunghezza 2m.



CODE CODICE	ARTICLE ARTICOLO	DESCRIPTION DESCRIZIONE
71 7010 1506	WSS 15x6	WallMax® Sealing Strip
71 7010 2005	WSS 20x5	WallMax® Sealing Strip
71 7010 2505	WSS 25x5	WallMax® Sealing Strip

Personalized Solutions

WallMax® provides customized mounting solutions for customers with specific needs. Different designs in terms of frames and flanges can be developed to accommodate special installations that cannot be executed with our standard product offer.

Soluzioni personalizzate

WallMax® è in grado di soddisfare speciali esigenze di installazione proponendo soluzioni personalizzate. Qualora la nostra offerta standard non dovesse rispondere alle Vostre necessità, saremo lieti di sviluppare alternative ad hoc in base alle Vostre richieste.

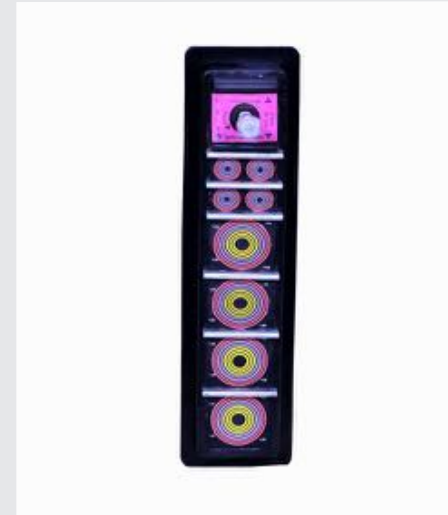

KIT/Fasteners/Sealing Appendix

Sealing Methods

• CONCRETE WALLS:

The roughness of the structure determines the gasket to be used between the flange and the structure.
For concrete with a smooth grinded surface use Fire Barrier Water Tight Sealant.
The Super Sealer No.10 Silicone Sealant or butyl sealing strip is recommended to achieve a good sealing against any small structural irregularities.
Cracks or voids might need plastering before installation.

• BRICKS WALLS:

For brick walls, Super Sealer No.10 Silicone Sealant is recommended to achieve a good sealing against the structural irregularities.
Cracks or voids need plastering before installation

• GYPSUM/WOOD/SANDWICH - PANELS:

In flat walls or floors composed by sandwich, wood, or gypsum panel, WallMax® recommends installing the WRHFF, SLVFWR or SLVFWRs frames/sleeves.
These frames and sleeves bolted in flat walls and floors are recommended to be installed using Super Sealer No.10 Silicone Sealant or a solid/cellular sealing strip.

• STEEL STRUCTURES:

In flat steel structures, such as cabinets, containers, or decks/bulkheads, WallMax® recommends WRHFF, flanged frames, SLVFWR/SLVFWRs sleeves.
For metal structures, or metal to metal mounting, EPDM solid/cellular sealing strips or pre-punched gaskets are recommended.
Pre-punched gaskets are solid EPDM gaskets with a pre-defined hole pattern corresponding to the frame or sleeve.
Foam gaskets are mechanical seals used to inhibit leaks between distinct substrate sections.
Due to the closed-cell structure of an EPDM sponge gasket, it is impermeable to air and water and is therefore an ideal material for sealing against such medium.

Metodi di Sigillatura:

• MURI DI CALCESTRUZZO:

La rugosità della struttura determina la guarnizione da utilizzare tra la flangia e la struttura.
Per il calcestruzzo con una superficie liscia e piana utilizzare il Sigillante a Tenuta Stagna Antideflagrante.
Il Sigillante Siliconico Super Sigillante No.10 o Strisce di Sigillatura Butilica sono consigliati per ottenere una buona tenuta contro eventuali irregolarità strutturali.
Le crepe e i vuoti potrebbero richiedere l'intonaco prima dell'installazione.

• MURI DI MATTONI:

Per muri di mattoni, il Sigillante Siliconico Super Sigillante No.10 è consigliato per ottenere una buona tenuta contro eventuali irregolarità strutturali.
Le crepe e i vuoti potrebbero richiedere l'intonaco prima dell'installazione.





• GESSO/LEGNO/SANDWICH - PANNELLI:

Con muri o pavimenti piani composti da pannelli sandwich, di legno o di gesso, Wallmax® consiglia di installare cornici/manicotti WRHFF, SLVFWR o SLVFWRs.
Per queste cornici e manicotti imbullonati ai muri o pavimenti piani sono consigliati per l'installazione il Sigillante Siliconico Super Sigillante No.10 oppure un nastro sigillante solido/a celle.

• STRUTTURE D'ACCIAIO:

In strutture d'acciaio piane, come armadietti, containers, o ponti/paratie, Wallmax® consiglia di utilizzare WRHFF, cornici flangiate, manicotti SLVFWR/SLVFWRs.
Per strutture metalliche, o assemblaggi di metallo su metallo, sono consigliati nastri sigillanti in EPDM solidi/a celle o guarnizioni pre-forate.
Le guarnizioni pre-forate sono di tipo EPDM solido con dei fori predefiniti corrispondenti alla formetria della cornice o del manicotto.
Le guarnizioni di materiali espansi sono sigilli meccanici utilizzati per inibire le perdite tra sezioni distinte del substrato.
La struttura a celle chiuse a spugna in EPDM rende la guarnizione impermeabile all'aria e all'acqua ed è quindi un materiale ideale per la sigillatura.





Fasteners/Fissaggi

MATERIAL MATERIALE	PHOTO FOTO	ENGLISH DESCRIPTION DESCRIZIONE INGLESE	ITALIAN DESCRIPTION DESCRIZIONE ITALIANA
Concrete and Brick Walls - Muri di Calcestruzzo e Mattoni		Anchor bolts are recommended for concrete and brick walls to provide a strong joint for heavy design elements. In structures where there is a considerable risk of cracks due to the anchor bolt, a concrete screw should be used. The fasteners should be of the same type of material as the frame.	I bulloni d'ancoraggio sono consigliati per pareti in calcestruzzo e mattoni per fornire una giunzione forte per elementi di design pesanti. Nelle strutture dove esiste un notevole rischio di crepe dovuta al bullone di ancoraggio, si deve utilizzare una vite per calcestruzzo. I fissaggi devono essere dello stesso tipo di materiale del telaio.
Lightweight Concrete - Calcestruzzo Leggero		In lightweight materials, a concrete screw is recommended. The safe distance from the aperture to avoid cracks in the structure is smaller than for anchor bolts but wide flanged frames is still recommended. The fasteners should be of the same type of material as the frame.	Nei materiali leggeri è consigliata una vite per calcestruzzo. La distanza sicura dall'apertura per evitare fessure nella struttura è minore di quella per i bulloni di ancoraggio ma è comunque raccomandata una struttura a flangia larga. I fissaggi devono essere dello stesso tipo di materiale del telaio.
Steel Structures - Strutture d'Acciaio		In steel structures, a standard socket/hexagonal head screw is recommended. The fasteners should be of the same type of material as the frame. Note: When mounted in through holes, a sealing washer should be applied to prevent leakage through the joint.	Nelle strutture in acciaio si raccomanda una vite standard con vite a testa esagonale. I fissaggi devono essere dello stesso tipo di materiale del telaio. Nota: Nella fase di montaggio nei fori passanti, è necessario applicare una rondella di tenuta per evitare perdite attraverso il giunto.
Wood/Steel Studs - Chiodi di Legno/Acciaio		When bolted in construction elements the frame must be firmly attached in the loadbearing structure. A standard wood screw should be used in wood and in steel studs a self-drilling, self-tapping screw is recommended. Fasteners should be of the same type of material as the frame.	Quando è fissato a elementi costruttivi, il telaio deve essere saldamente fissato alla struttura portante. Una vite standard in legno deve essere utilizzata per il medesimo materiale o viti in acciaio autofilettanti. I fissaggi devono essere dello stesso tipo di materiale del telaio.

Frames Fixing Table/Tabella Fissaggio Cornici

Installation Type - Tipo d'Installazione	WRF	WRF2	WRD	WFO	WRF 2-4-6	WRF	WRF0	WRFL	WRFL0	WRHF	WRHFO	WRHFL	WRHFLO	WMF	WM mini R	WCC PA	WM PA & WM C PA	WX 200 PA	WMFC PA
Welding - Saldatura	X	X	X	X	X	X	X	X	X										
Cast in Wall - Muratura						X	X	X	X	X	X	X	X	X					
Bolting - Imbullonatura										X	X	X	X	X	X	X	X	X	X

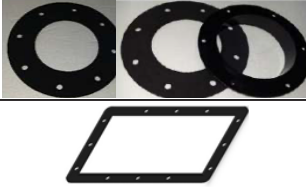
Application Tables of Gaskets and Sealants on Frames Tabella Applicazione Guarnizioni e Sigillanti su Cornici

OBJECT OGGETTO	PHOTO FOTO	DESCRIPTION EN DESCRIZIONE EN	DESCRIPTION IT DESCRIZIONE IT
EPDM Strip - Striscia EPDM		EPDM cellular strip applied around a flanged frame.	Striscia a celle EPDM applicata attorno ad una cornice flangiata.
EPDM Solid Sealing Strip - Striscia EPDM Solida Sigillante		EPDM solid sealing strip applied around a flanged frame	Striscia a celle EPDM applicata attorno ad una cornice flangiata.
Pre-punched Solid Self-Adhesive Gasket - Guarnizione Pre-Forata Solida Auto-Adesiva		Round punched gasket mounted on a flanged sleeve Rectangular self adhesive punched gasket mounted on the frame before fixing to the opening.	Guarnizione pre-forata assemblata su manicotto flangiato. Guarnizione pre-forata auto-adesiva rettangolare assemblata sulla cornice prima di essere fissata sull'apertura.
EPDM Self-Adhesive Foam Gaskets - Guarnizione Auto-Adesiva EPDM di Materiale Espanso		EPDM self-adhesive foam gaskets are used to be mounted to light weighted frames like WM mini R to a cabinet.	Guarnizione a materiale espanso in EPDM auto-adesiva assemblata su cornici leggere come WM mini R sugli armadietti.
O-Ring		O-Ring is a type of washer used to provide a seal around a screw or bolt. O-Ring consists of an outer ring of a hard material, typically steel, and an inner ring of an elastomeric material that acts as a gasket.	L'O-Ring è un tipo di rondella utilizzato per fornire una sigillatura intorno ad una vite o bullone. L'O-Ring è costituito da un anello esterno di un materiale duro, in genere acciaio, e un anello interno di un materiale elastomerico che funge da guarnizione.
Sealant - Sigillante		Sealants are used to achieve a good sealing against any small structural irregularities, cracks or voids on the surface for installation of the frame.	I sigillanti vengono utilizzati per ottenere una buona tenuta contro eventuali piccole irregolarità strutturali, crepe o vuoti nella superficie per l'installazione della cornice.

Sealing Application Tables Tabella Applicazione Sigillature

Frames	WRF			WRFF/WRFFL			WRHFF/WRHFFL			WR/WRS with flanged sleeve			WM mini R
Installation Method	Casting/Welding			Casting/Welding			Casting/Bolting			Casting/Bolting			Bolting
Application Area	Concrete Wall	Brick Wall	Bulkhead/Deck	Concrete Wall	Brick Wall	Bulkhead/Deck	Concrete Wall	Brick Wall	Bulkhead/Deck	Concrete Wall	Brick Wall	Bulkhead/Deck	Cabinet
EPDM Strip						X			X				
Butyl Strip				X	X		X	X					
EPDM Pre-Punched Gasket						X	X	X	X	X	X	X	
EPDM Foam Punched Gasket													X
Sealant				X	X		X	X		X	X		

BILL OF MATERIAL

Item No.	Part Description	Material	Qty
01	WMS 20x40	15mm	1
02	WMS 20x40	15mm	1
03	WMS 20x40	15mm	1

ALL MODULES EXCEPT WMS 20x40 / WMS 15x40 1 CABINETS / MODULE

WMS 20x40 / WMS 15x40 2 CABINETS / MODULE

WMS 20x40 / WMS 15x40 3 CABINETS / MODULE

WMS 20x40 / WMS 15x40 1 CABINETS / MODULE

NOTE:-
▲ MODULES WMS 20x40 WITHOUT FUSION CENTER.

MODULE SIZES CHART

Item No.	MODULE TYPE	PART NO.	W (mm)	H (mm)	Depth (mm)	Height (mm)
01	WMS 15	71400001	33	33	2.5	33
02	WMS 20	71400002	46	33	2.5	33
03	WMS 20	71400003	33	33	4.5	33
04	WMS 20x40	71400004	46	20	4.5	20
05	WMS 20	71400005	33	33	6.5	20
06	WMS 20	71400006	46	33	6.5	20
07	WMS 20	71400007	46	33	8.5	20
08	WMS 20	71400008	46	33	10.5	20
09	WMS 20	71400009	46	33	12.5	20
10	WMS 20	71400010	46	33	14.5	20
11	WMS 20	71400011	46	33	16.5	20
12	WMS 20	71400012	46	33	18.5	20
13	WMS 20	71400013	46	33	20.5	20
14	WMS 20	71400014	46	33	22.5	20
15	WMS 20	71400015	46	33	24.5	20

COMPANY LOGO PRINTED ON FACE

MODULE SIZES CHART

Item No.	MODULE TYPE	PART NO.	W (mm)	H (mm)
01	WMS 15	71400016	33	33
02	WMS 20x40	71400017	46	20
03	WMS 15	71400018	33	33
04	WMS 20	71400019	20	20
05	WMS 20	71400020	20	20
06	WMS 40	71400021	40	40
07	WMS 60	71400022	60	60
08	WMS 50x50	71400023	50	50
09	WMS 50x50	71400024	60	60
10	WMS 50x50	71400025	60	60
11	WMS 50x50	71400026	70	70
12	WMS 50x50	71400027	60	70
13	WMS 50x50	71400028	60	80
14	WMS 20x40	71400029	40	20
15	WMS 15x40	71400030	40	15

NOTE:-
▲ SOLID MODULES ARE SOLID PPM NUMBER BLOCK.

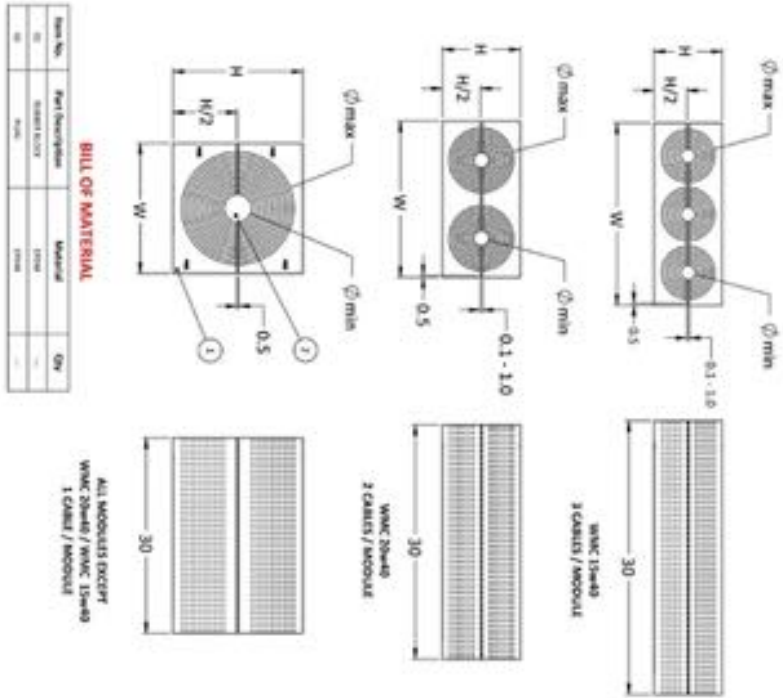

MODULE SIZES CHART

Item No.	Module Type	Part No.	W (mm)	H (mm)	ϕ (mm)	ϕ (mm)
01	WMC 15	71300015A	15	25	1.3	11.0
02	WMC 20x40	71300020A	40	25	2.3	11.0
03	WMC 20	71300020B	20	25	4	11.0
04	WMC 20x40	71300020C	40	25	4	11.0
05	WMC 30	71300030A	30	35	1.5	21
06	WMC 20x40	71300020D	40	35	1.5	21
07	WMC 40	71300040A	40	45	2.5	11.0
08	WMC 40 1/2	71300040B	40	45	3	11.0
09	WMC 50	71300050A	50	55	2.5	40
10	WMC 50 1/2	71300050B	50	55	3	40
11	WMC 60	71300060A	60	65	2.5	40
12	WMC 60 1/2	71300060B	60	65	3	40
13	WMC 70x40	71300070A	40	75	2.5	40
14	WMC 70x40	71300070B	40	75	3	40
15	WMC 15x40	71300015B	40	15	1.3	11.0



MODULE SIZES CHART

Item No.	Module Type	Part No.	W (mm)	H (mm)	ϕ (mm)	H (mm)
01	WMSC 15x20	71300015A	15	20	5	5
02	WMSC 10x20	71300010A	10	20	10	10
03	WMSC 15	71300015B	15	15	15	15
04	WMSC 20	71300020A	20	20	20	20
05	WMSC 30	71300030A	30	30	30	30
06	WMSC 40	71300040A	40	40	40	40
07	WMSC 60	71300060A	60	60	60	60
08	WMSC 50	71300050A	50	50	5	5
09	WMSC 50	71300050B	50	50	5	5
10	WMSC 50	71300050C	50	50	5	5
11	WMSC 50	71300050D	50	50	5	5
12	WMSC 25x30	71300125A	30	25	25	25
13	WMSC 25x40	71300125B	40	25	25	25
14	WMSC 27x40	71300127A	40	27	27	27
15	WMSC 15x40	71300115A	40	15	15	15

NOTE:-
SOLID MODULES ARE SOLID BRASS RUBBER BLOCK

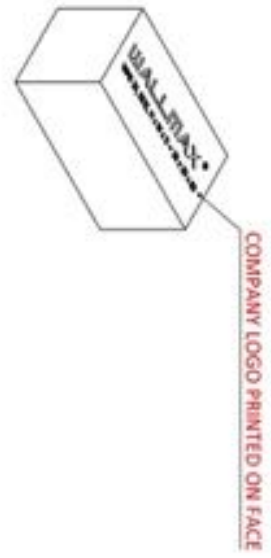

WRF General Product Datasheet

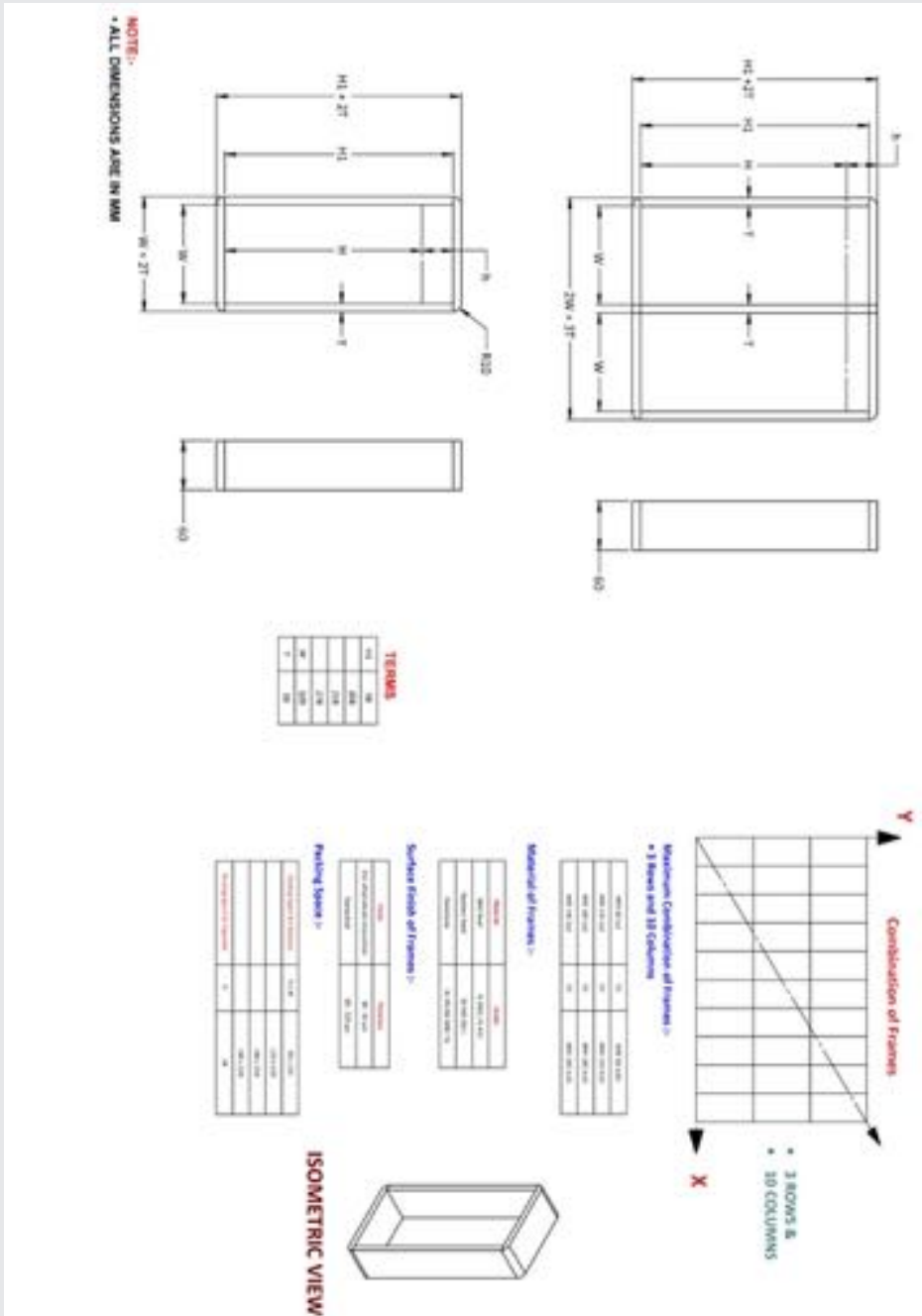

WRF2 General Product Datasheet

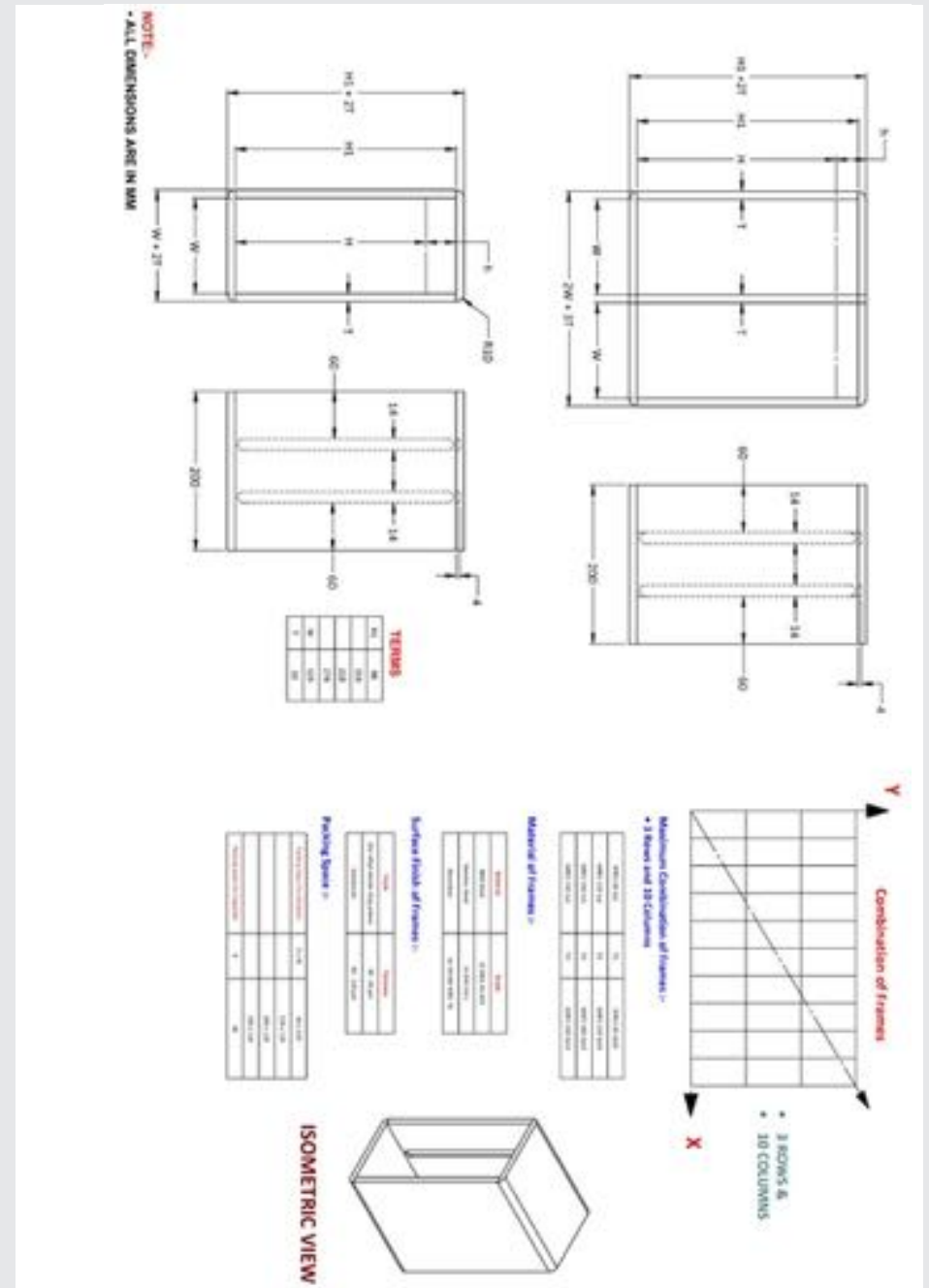

WRFD General Product Datasheet

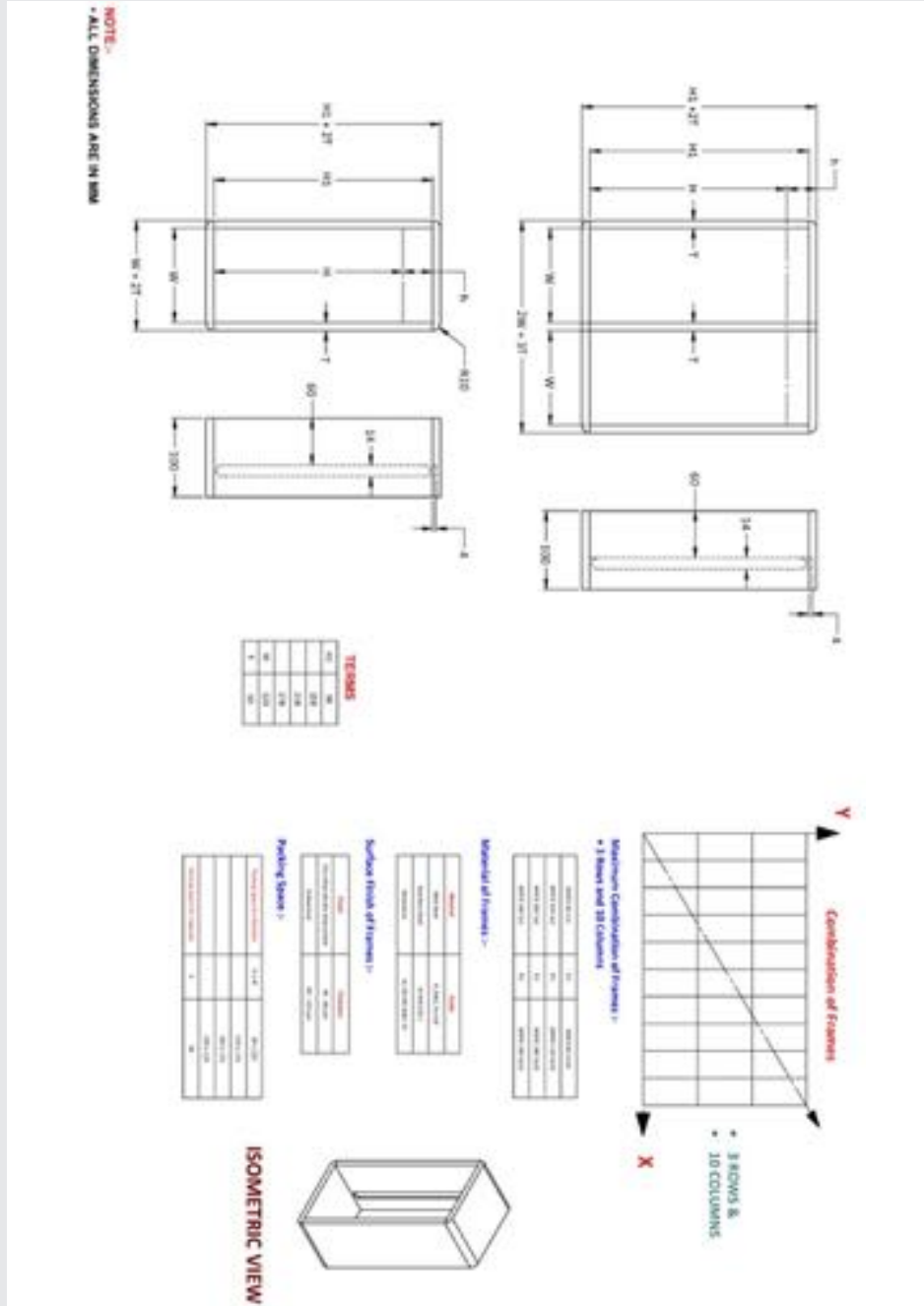

WRFO General Product Datasheet

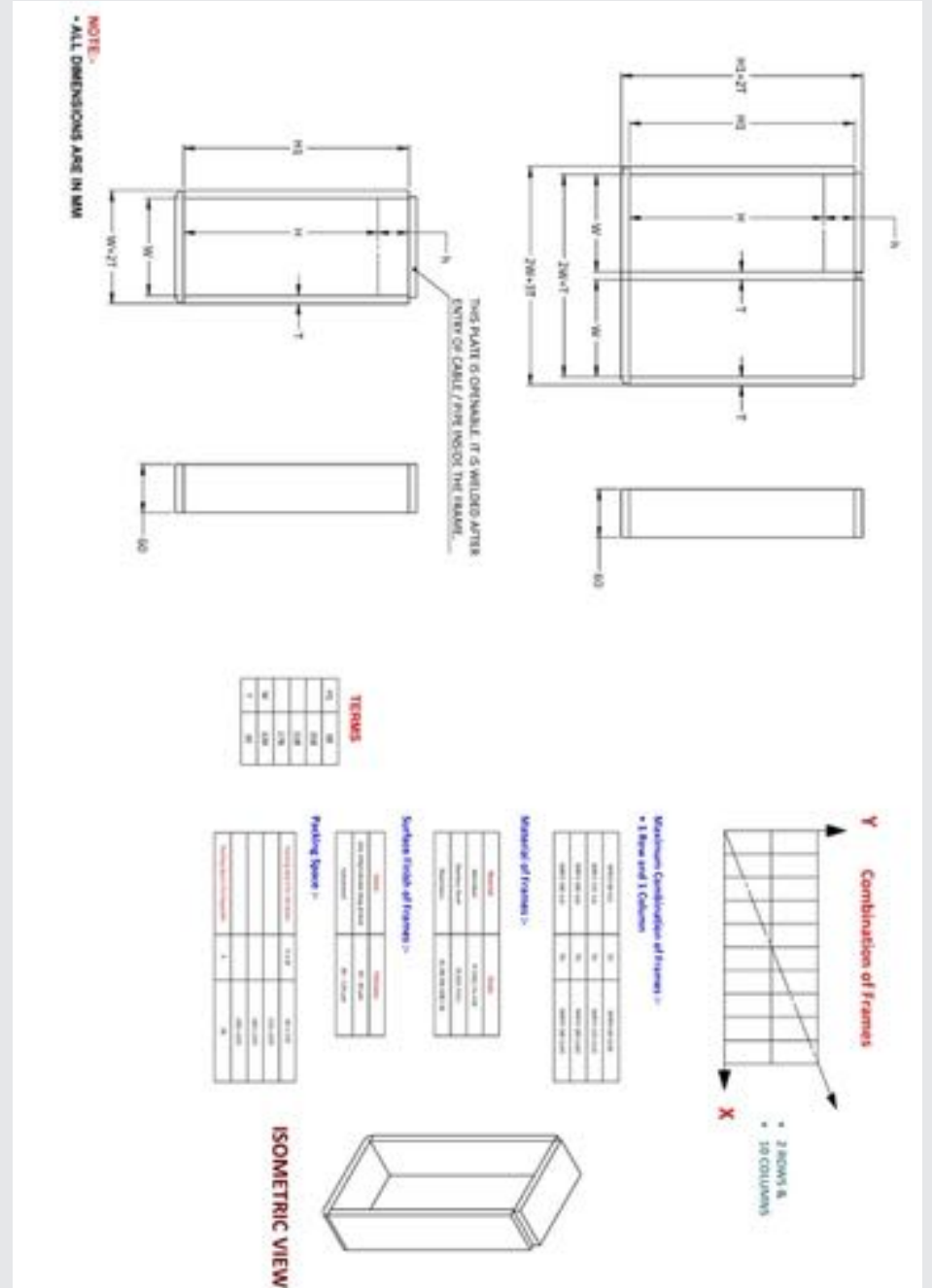

WRFR2 General Product Datasheet

WallMax®
PRODUCT CATALOGUE

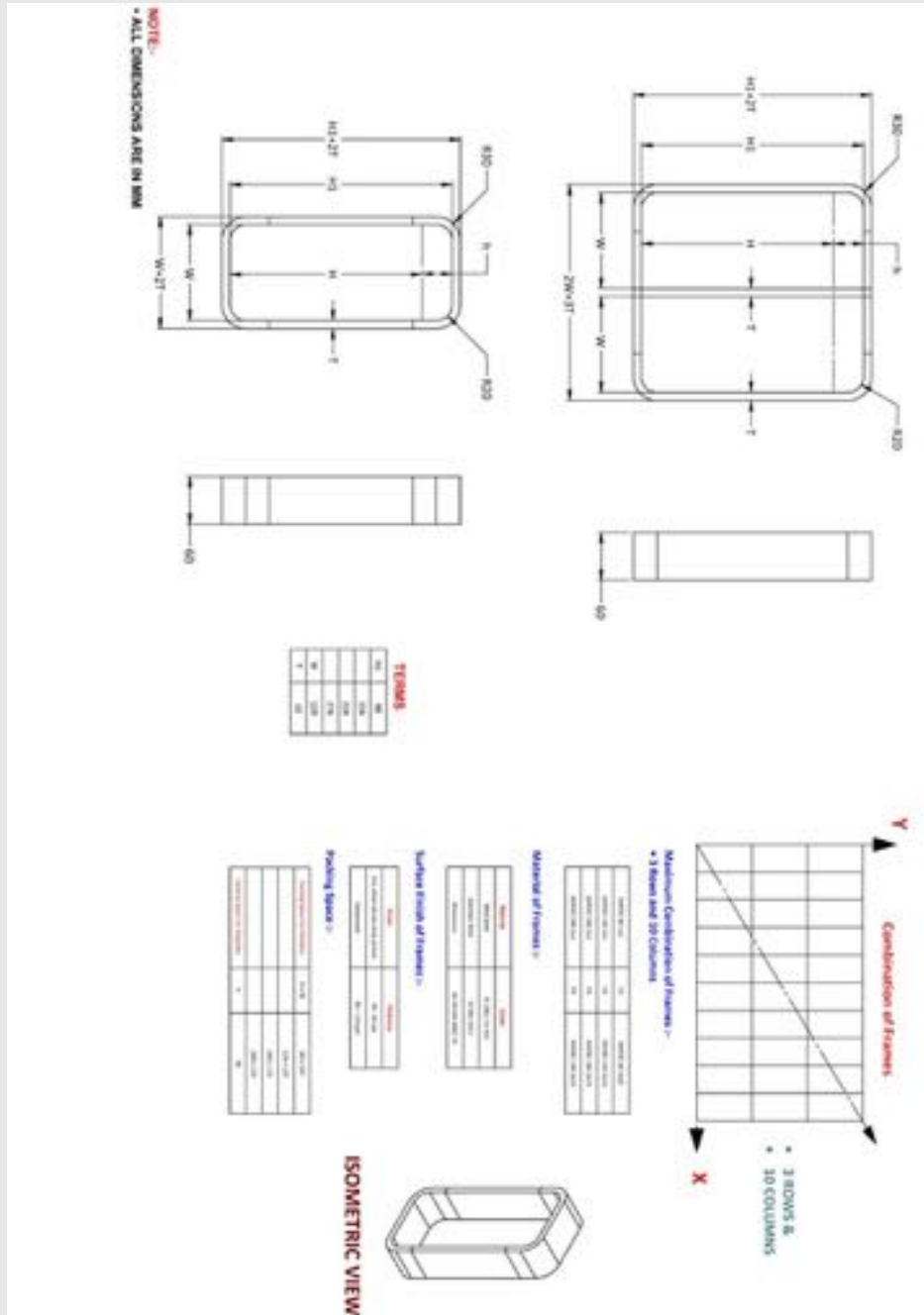

WRFR4 General Product Datasheet

WallMax®
PRODUCT CATALOGUE

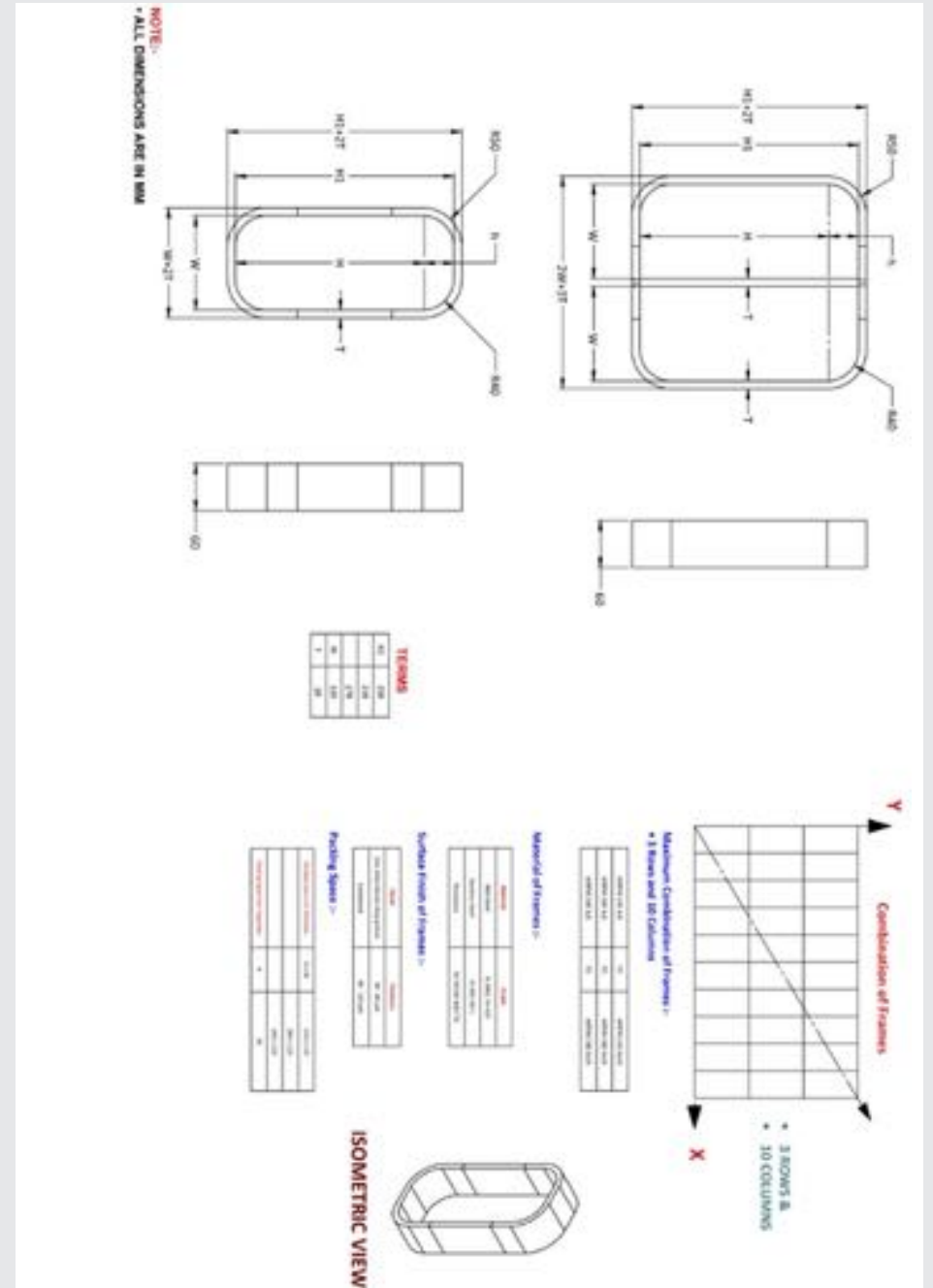

WRF General Product Datasheet

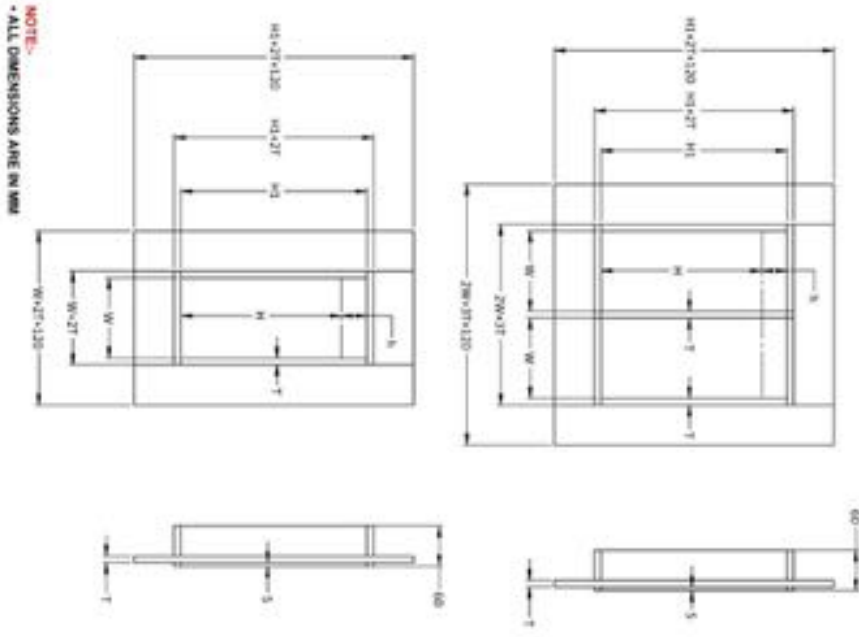

NOTE: ALL DIMENSIONS ARE IN MM

TERMS

W	W	W	W	W	W
H	H	H	H	H	H
T	T	T	T	T	T
B	B	B	B	B	B

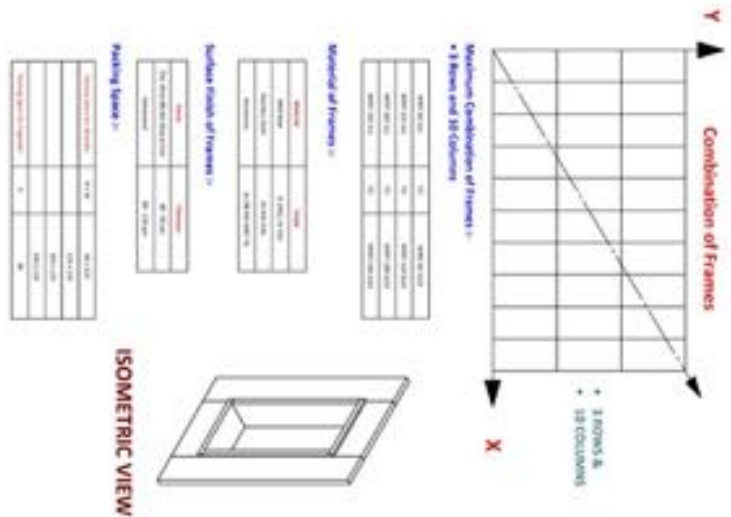

WRFFO General Product Datasheet

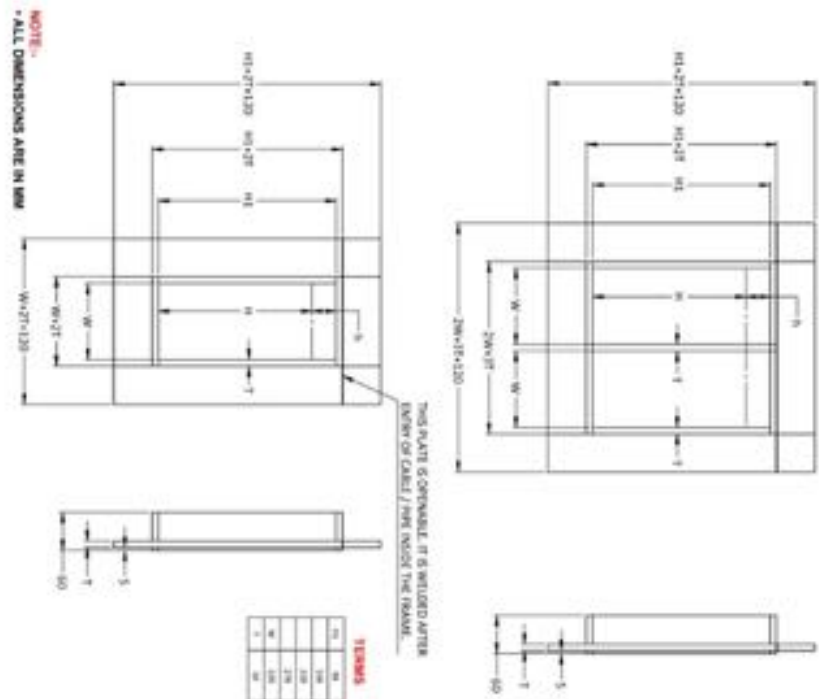

NOTE: ALL DIMENSIONS ARE IN MM

THIS PLATE IS CORNABLE. IT IS WRITTED AFTER ENTRY OF CABEL / PANE UNDER THE FRAME.

TERMS

W	W	W	W	W	W
H	H	H	H	H	H
T	T	T	T	T	T
B	B	B	B	B	B

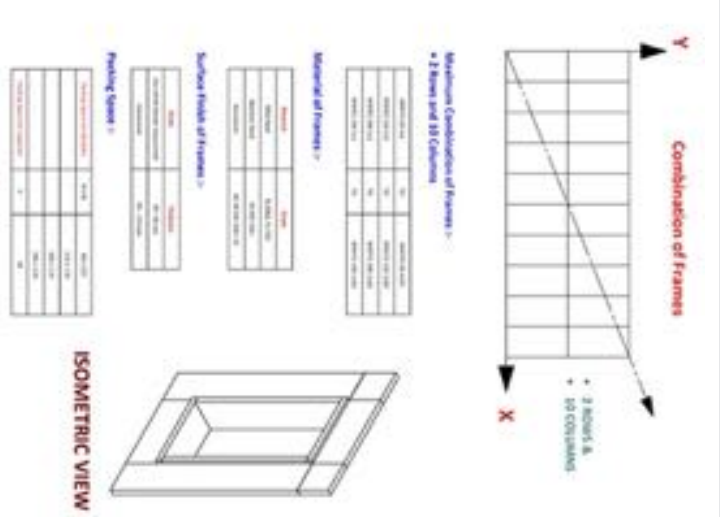

WRFFL General Product Datasheet

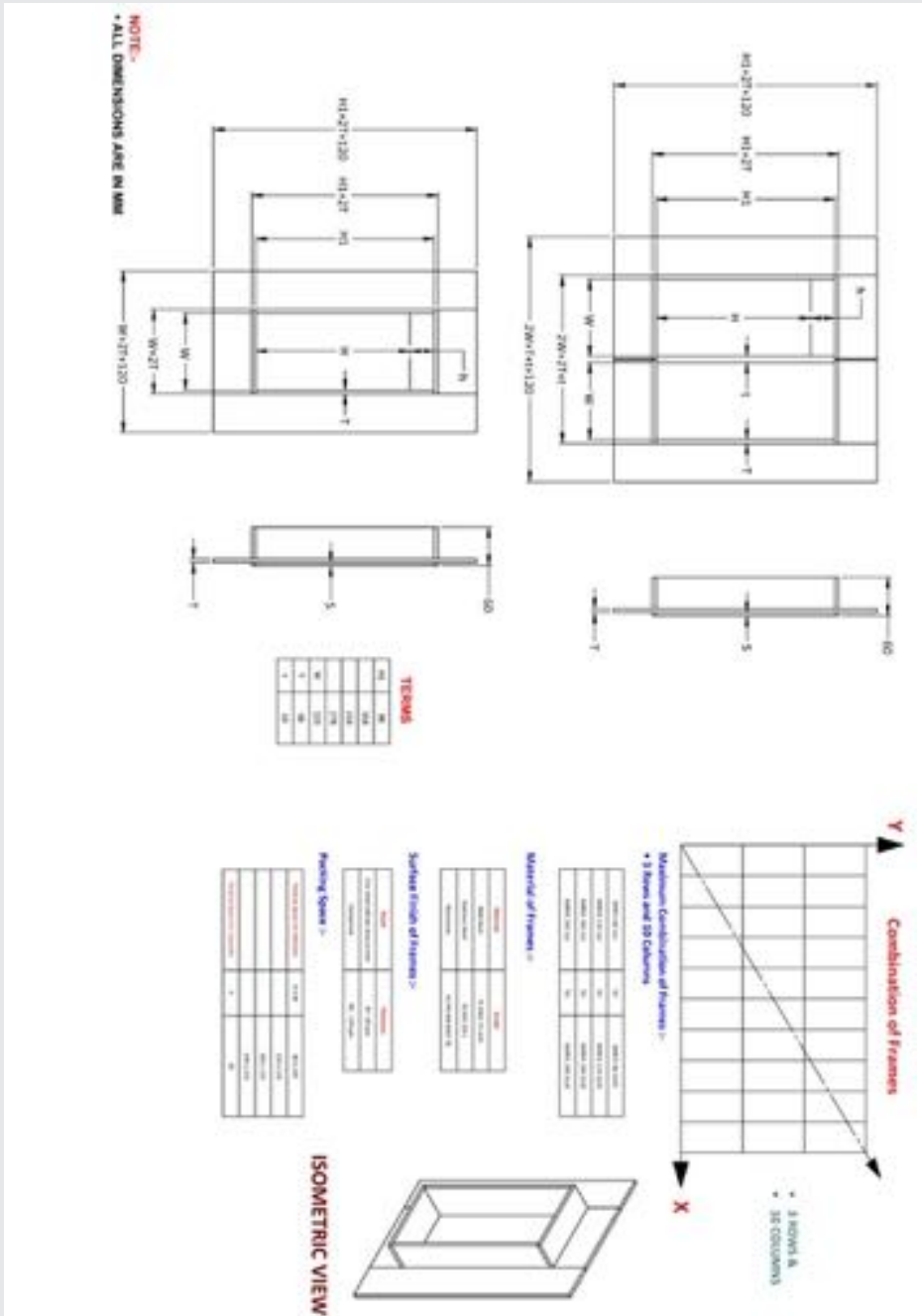

WRHFF General Product Datasheet

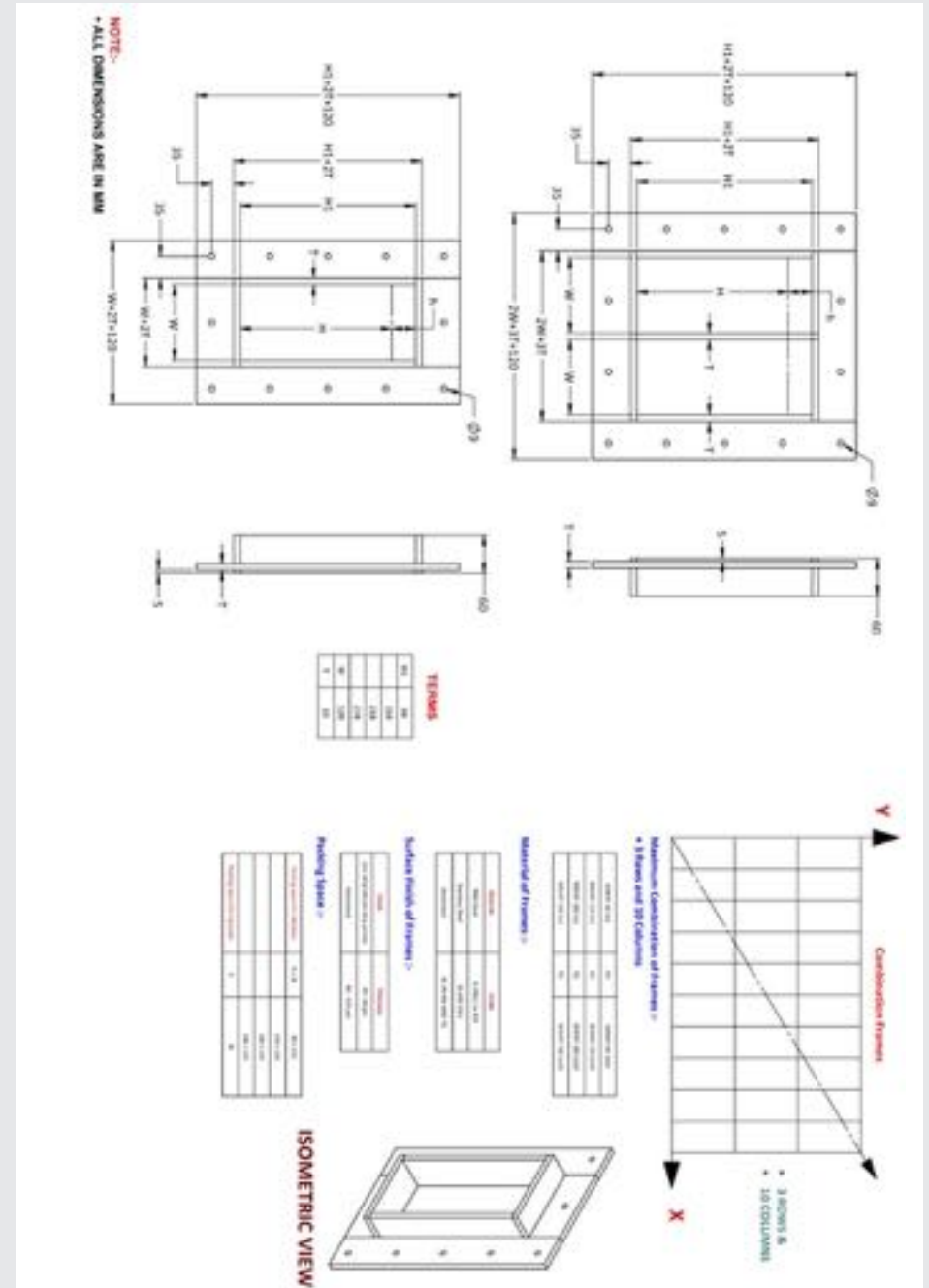

WRHFFL General Product Datasheet

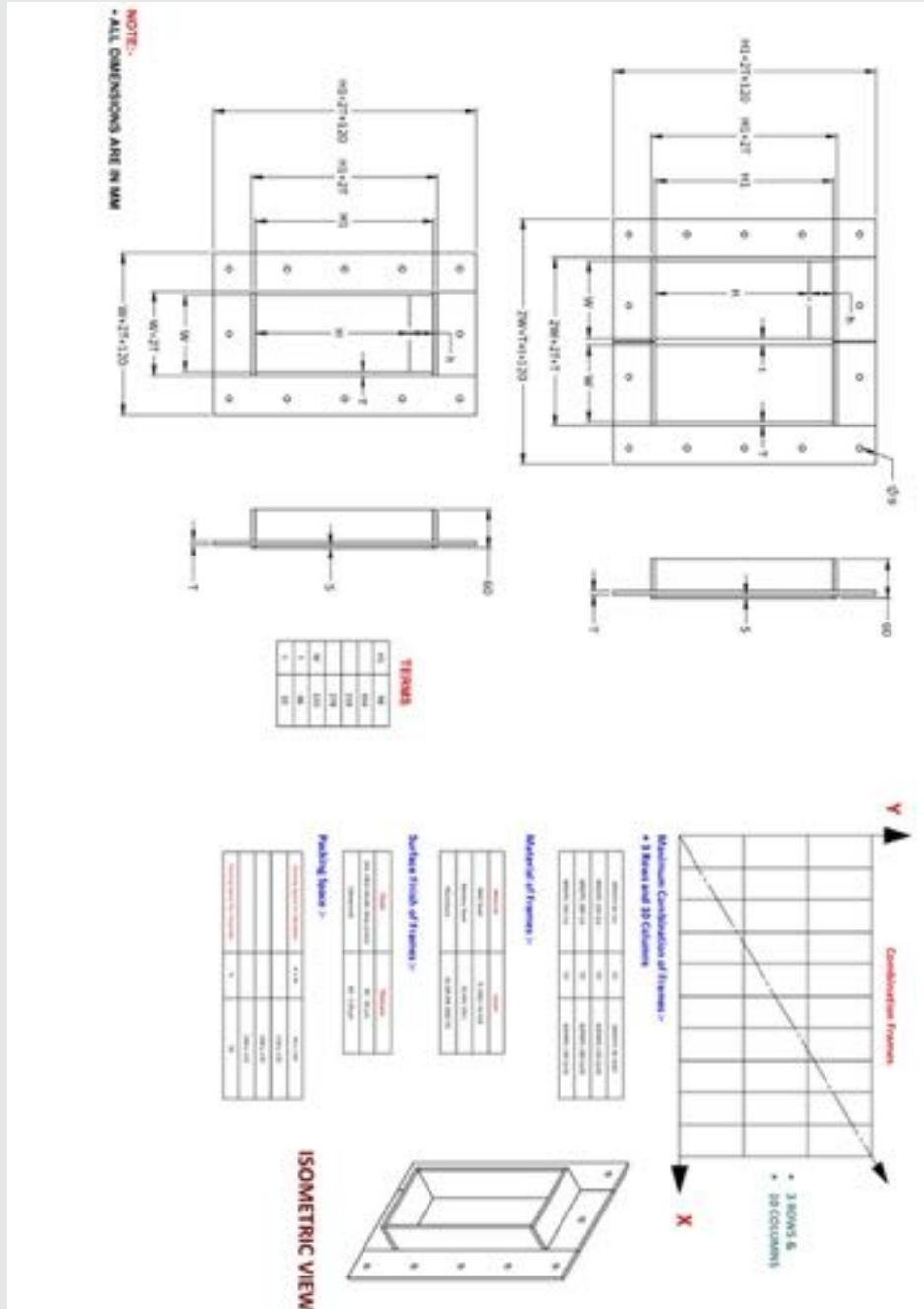

WMF General Product Datasheet

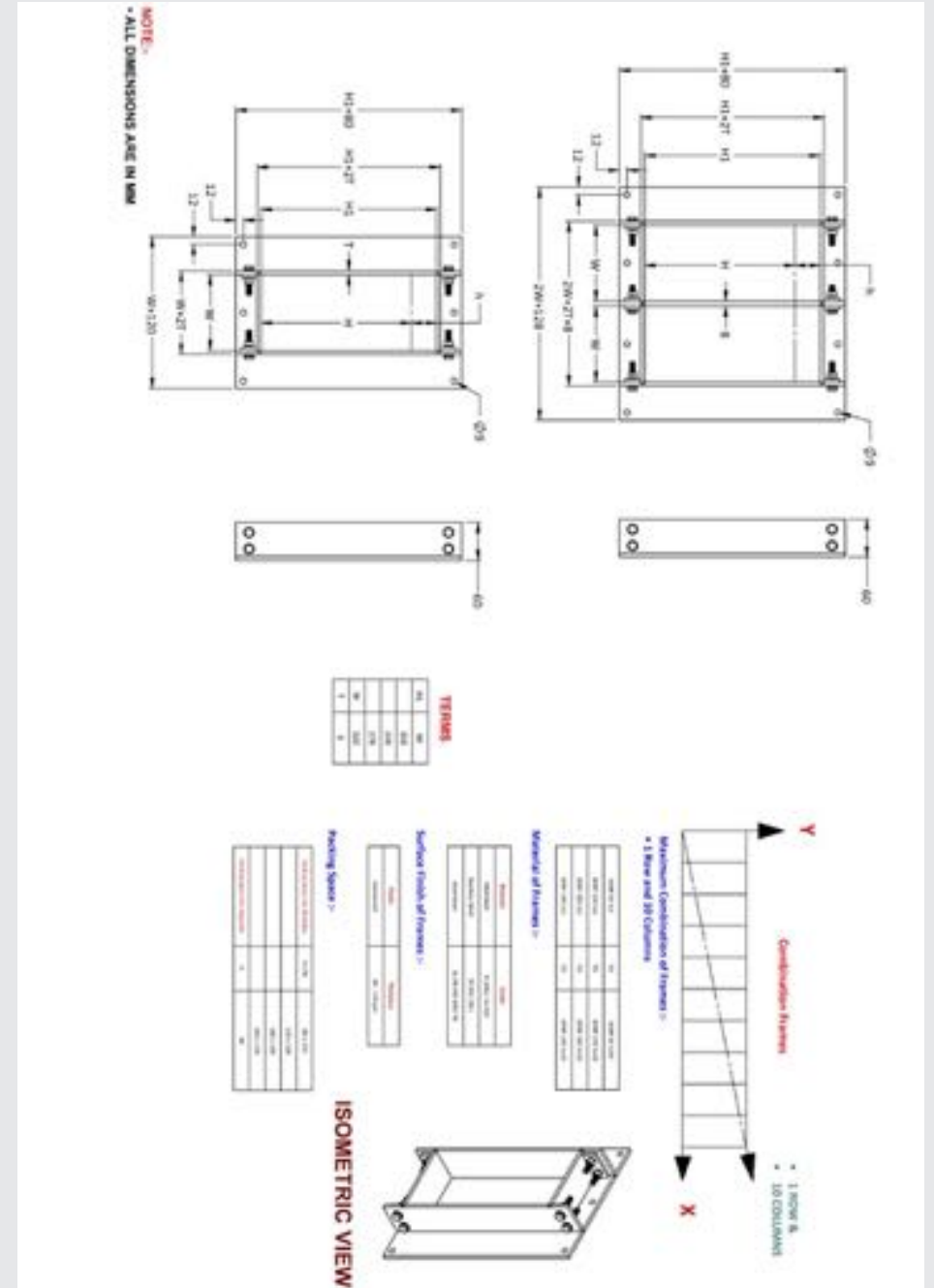

WR SS316 General Product Datasheet

WallMax®
PRODUCT CATALOGUE

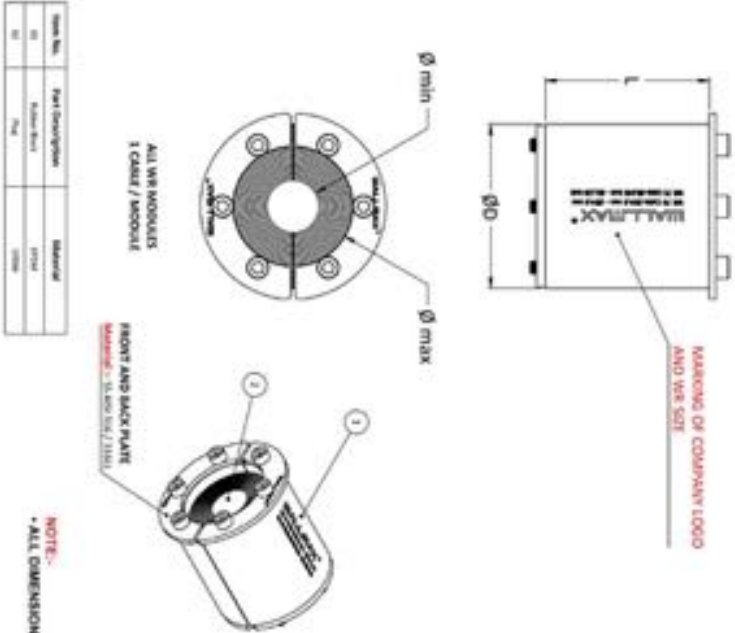

NOTE:-
• ALL DIMENSIONS ARE IN MM

WR MODULE SIZES CHART

Item No.	MODULE TYPE	PART NO.	ØD (mm)	Ø (mm)	Ømax (mm)	Ømin (mm)	Ømax (mm)
01	WR 21 ADP 316	711010001	71	37.5	5.6	11.8	
02	WR 21 ADP 316	711010003	71	37.5	5.6	12.8	
03	WR 21 ADP 316	711010004	71	37.5	5.6	13.8	
04	WR 21 ADP 316	711010005	71	37.5	5.6	14.8	
05	WR 21 ADP 316	711010006	71	37.5	5.6	15.8	
06	WR 21 ADP 316	711010007	71	37.5	5.6	16.8	
07	WR 21 ADP 316	711010008	71	37.5	5.6	17.8	
08	WR 21 ADP 316	711010009	71	37.5	5.6	18.8	
09	WR 21 ADP 316	711010010	71	37.5	5.6	19.8	
10	WR 21 ADP 316	711010011	71	37.5	5.6	20.8	
11	WR 21 ADP 316	711010012	71	37.5	5.6	21.8	
12	WR 21 ADP 316	711010013	71	37.5	5.6	22.8	
13	WR 21 ADP 316	711010014	71	37.5	5.6	23.8	
14	WR 21 ADP 316	711010015	71	37.5	5.6	24.8	
15	WR 21 ADP 316	711010016	71	37.5	5.6	25.8	
16	WR 21 ADP 316	711010017	71	37.5	5.6	26.8	
17	WR 21 ADP 316	711010018	71	37.5	5.6	27.8	

NOTE:- INDICATES WR MODULE WITHOUT FLUID IN CENTER

SLVWR General Product Datasheet

WallMax®
PRODUCT CATALOGUE

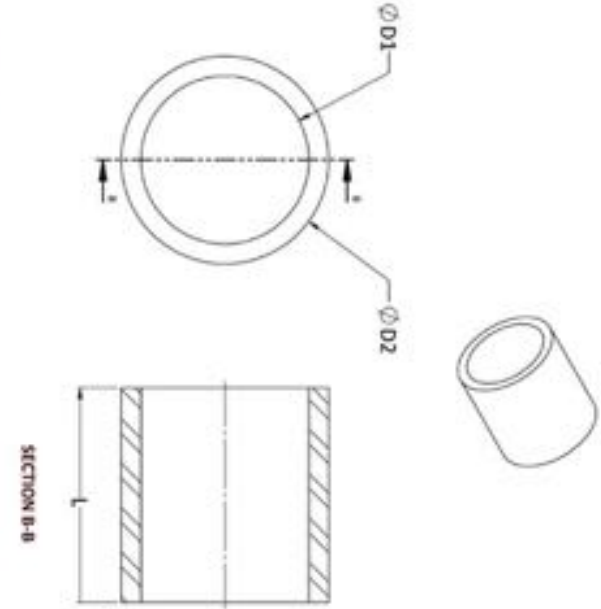

NOTE:-
• ALL DIMENSIONS ARE IN MM

SLVWR SIZES CHART

Item No.	SLVWR TYPE	PART NO.	ØD (mm)	Ø (mm)	Ø1 (mm)	Ø2 (mm)	Ømax (mm)
01	SLVWR 21 ADP 316	711010019	71	37.5	5.6	11.8	
02	SLVWR 21 ADP 316	711010020	71	37.5	5.6	12.8	
03	SLVWR 21 ADP 316	711010021	71	37.5	5.6	13.8	
04	SLVWR 21 ADP 316	711010022	71	37.5	5.6	14.8	
05	SLVWR 21 ADP 316	711010023	71	37.5	5.6	15.8	
06	SLVWR 21 ADP 316	711010024	71	37.5	5.6	16.8	
07	SLVWR 21 ADP 316	711010025	71	37.5	5.6	17.8	
08	SLVWR 21 ADP 316	711010026	71	37.5	5.6	18.8	
09	SLVWR 21 ADP 316	711010027	71	37.5	5.6	19.8	
10	SLVWR 21 ADP 316	711010028	71	37.5	5.6	20.8	
11	SLVWR 21 ADP 316	711010029	71	37.5	5.6	21.8	
12	SLVWR 21 ADP 316	711010030	71	37.5	5.6	22.8	
13	SLVWR 21 ADP 316	711010031	71	37.5	5.6	23.8	
14	SLVWR 21 ADP 316	711010032	71	37.5	5.6	24.8	
15	SLVWR 21 ADP 316	711010033	71	37.5	5.6	25.8	
16	SLVWR 21 ADP 316	711010034	71	37.5	5.6	26.8	
17	SLVWR 21 ADP 316	711010035	71	37.5	5.6	27.8	
18	SLVWR 21 ADP 316	711010036	71	37.5	5.6	28.8	
19	SLVWR 21 ADP 316	711010037	71	37.5	5.6	29.8	
20	SLVWR 21 ADP 316	711010038	71	37.5	5.6	30.8	

NOTE:-
• SLVWR IS USED WITH WR MODULES.

SLVFWR General Product Datasheet

WALMAX®
PRODUCT CATALOGUE

NOTE:-
• ALL DIMENSIONS ARE IN MM

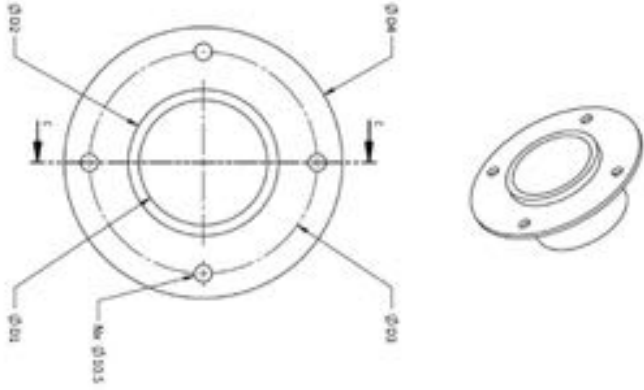

SECTION C-C

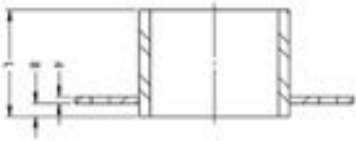

NOTE:-

• SLVFWR IS USED WITH 888 MODULES

SLVFWR SIZES CHART

Item No.	SLVFWR TYPE	SLVFWR SIZE	SLVFWR DIMENSIONS	WIRE	WIRE LENGTH	WIRE WEIGHT	WIRE LENGTH	WIRE WEIGHT	WIRE LENGTH	WIRE WEIGHT	WIRE LENGTH	WIRE WEIGHT
1	SLVFWR 100	100	100	100	100	100	100	100	100	100	100	100
2	SLVFWR 150	150	150	150	150	150	150	150	150	150	150	150
3	SLVFWR 200	200	200	200	200	200	200	200	200	200	200	200
4	SLVFWR 250	250	250	250	250	250	250	250	250	250	250	250
5	SLVFWR 300	300	300	300	300	300	300	300	300	300	300	300
6	SLVFWR 350	350	350	350	350	350	350	350	350	350	350	350
7	SLVFWR 400	400	400	400	400	400	400	400	400	400	400	400
8	SLVFWR 450	450	450	450	450	450	450	450	450	450	450	450
9	SLVFWR 500	500	500	500	500	500	500	500	500	500	500	500
10	SLVFWR 550	550	550	550	550	550	550	550	550	550	550	550
11	SLVFWR 600	600	600	600	600	600	600	600	600	600	600	600
12	SLVFWR 650	650	650	650	650	650	650	650	650	650	650	650
13	SLVFWR 700	700	700	700	700	700	700	700	700	700	700	700
14	SLVFWR 750	750	750	750	750	750	750	750	750	750	750	750
15	SLVFWR 800	800	800	800	800	800	800	800	800	800	800	800
16	SLVFWR 850	850	850	850	850	850	850	850	850	850	850	850
17	SLVFWR 900	900	900	900	900	900	900	900	900	900	900	900
18	SLVFWR 950	950	950	950	950	950	950	950	950	950	950	950
19	SLVFWR 1000	1000	1000	1000	1000	1000	1000	1000	1000	1000	1000	1000

WRS General Product Datasheet

WALMAX®
PRODUCT CATALOGUE

NOTE:-
• ALL DIMENSIONS ARE IN MM

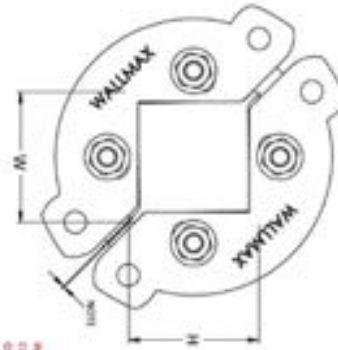

NOTE:-
• ALL DIMENSIONS ARE IN MM

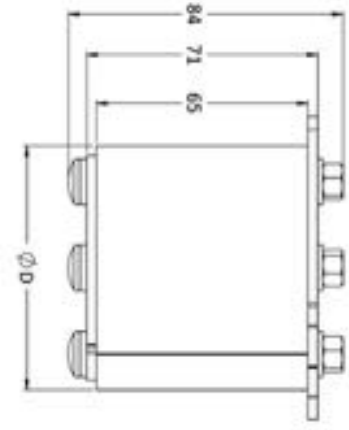
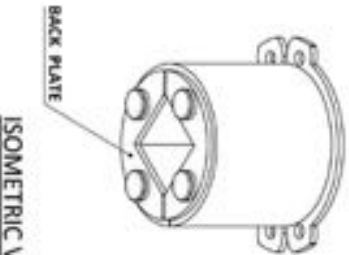
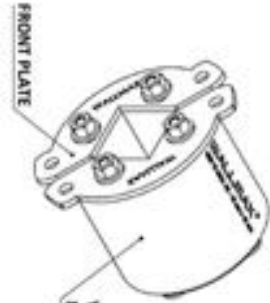

WRS / WRSO FRAME SIZES CHART WITH PACKING SPACE

Item No.	WRSO TYPE	WRSO SIZE	WRSO DIMENSIONS	WRSO WEIGHT
01	WRSO / WRSO 50	50	50	50
02	WRSO / WRSO 75	75	75	75
03	WRSO / WRSO 100	100	100	100
04	WRSO / WRSO 125	125	125	125
05	WRSO / WRSO 150	150	150	150
06	WRSO / WRSO 175	175	175	175
07	WRSO / WRSO 200	200	200	200
08	WRSO / WRSO 225	225	225	225
09	WRSO / WRSO 250	250	250	250

NOTE:-

• PACKING SPACE FOR WRSO MODULE = 8 X 8 X 8

MATERIAL OR FRONT AND BACK PLATE OR WRSO / WRSO SIZES

Material	Front Plate	Back Plate	WRSO / WRSO SIZES
EPDM RUBBER	100	100	100
EPDM RUBBER	150	150	150
EPDM RUBBER	200	200	200
EPDM RUBBER	250	250	250
EPDM RUBBER	300	300	300
EPDM RUBBER	350	350	350
EPDM RUBBER	400	400	400
EPDM RUBBER	450	450	450
EPDM RUBBER	500	500	500
EPDM RUBBER	550	550	550
EPDM RUBBER	600	600	600
EPDM RUBBER	650	650	650
EPDM RUBBER	700	700	700
EPDM RUBBER	750	750	750
EPDM RUBBER	800	800	800
EPDM RUBBER	850	850	850
EPDM RUBBER	900	900	900
EPDM RUBBER	950	950	950
EPDM RUBBER	1000	1000	1000

NOTE:-
• ALL DIMENSIONS ARE IN MM

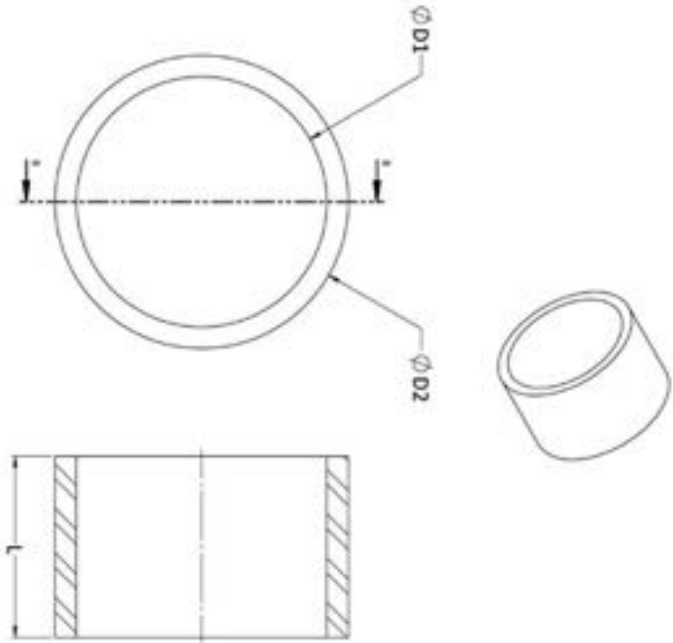

SLVWRS SIZES CHART

SLVWRS TYPE	SUBJECTIVE	ASST. VTL.	MATERIAL	WINGS	Ø1 (mm)	Ø2 (mm)	Ø3 (mm)	Ø4 (mm)	Ø5 (mm)
1	SLVWRS 10 (30MM)	10x10x10MM	AL2024 T3	Ø10x10x10	10	10	10	10	10
2	SLVWRS 15 (30MM)	15x15x15MM	AL2024 T3	Ø15x15x15	15	15	15	15	15
3	SLVWRS 20 (30MM)	20x20x20MM	AL2024 T3	Ø20x20x20	20	20	20	20	20
4	SLVWRS 25 (30MM)	25x25x25MM	AL2024 T3	Ø25x25x25	25	25	25	25	25
5	SLVWRS 30 (30MM)	30x30x30MM	AL2024 T3	Ø30x30x30	30	30	30	30	30
6	SLVWRS 35 (30MM)	35x35x35MM	AL2024 T3	Ø35x35x35	35	35	35	35	35
7	SLVWRS 40 (30MM)	40x40x40MM	AL2024 T3	Ø40x40x40	40	40	40	40	40
8	SLVWRS 45 (30MM)	45x45x45MM	AL2024 T3	Ø45x45x45	45	45	45	45	45
9	SLVWRS 50 (30MM)	50x50x50MM	AL2024 T3	Ø50x50x50	50	50	50	50	50
10	SLVWRS 55 (30MM)	55x55x55MM	AL2024 T3	Ø55x55x55	55	55	55	55	55
11	SLVWRS 60 (30MM)	60x60x60MM	AL2024 T3	Ø60x60x60	60	60	60	60	60
12	SLVWRS 65 (30MM)	65x65x65MM	AL2024 T3	Ø65x65x65	65	65	65	65	65
13	SLVWRS 70 (30MM)	70x70x70MM	AL2024 T3	Ø70x70x70	70	70	70	70	70
14	SLVWRS 75 (30MM)	75x75x75MM	AL2024 T3	Ø75x75x75	75	75	75	75	75
15	SLVWRS 80 (30MM)	80x80x80MM	AL2024 T3	Ø80x80x80	80	80	80	80	80
16	SLVWRS 85 (30MM)	85x85x85MM	AL2024 T3	Ø85x85x85	85	85	85	85	85
17	SLVWRS 90 (30MM)	90x90x90MM	AL2024 T3	Ø90x90x90	90	90	90	90	90
18	SLVWRS 95 (30MM)	95x95x95MM	AL2024 T3	Ø95x95x95	95	95	95	95	95
19	SLVWRS 100 (30MM)	100x100x100MM	AL2024 T3	Ø100x100x100	100	100	100	100	100
20	SLVWRS 105 (30MM)	105x105x105MM	AL2024 T3	Ø105x105x105	105	105	105	105	105
21	SLVWRS 110 (30MM)	110x110x110MM	AL2024 T3	Ø110x110x110	110	110	110	110	110
22	SLVWRS 115 (30MM)	115x115x115MM	AL2024 T3	Ø115x115x115	115	115	115	115	115
23	SLVWRS 120 (30MM)	120x120x120MM	AL2024 T3	Ø120x120x120	120	120	120	120	120
24	SLVWRS 125 (30MM)	125x125x125MM	AL2024 T3	Ø125x125x125	125	125	125	125	125
25	SLVWRS 130 (30MM)	130x130x130MM	AL2024 T3	Ø130x130x130	130	130	130	130	130
26	SLVWRS 135 (30MM)	135x135x135MM	AL2024 T3	Ø135x135x135	135	135	135	135	135
27	SLVWRS 140 (30MM)	140x140x140MM	AL2024 T3	Ø140x140x140	140	140	140	140	140
28	SLVWRS 145 (30MM)	145x145x145MM	AL2024 T3	Ø145x145x145	145	145	145	145	145
29	SLVWRS 150 (30MM)	150x150x150MM	AL2024 T3	Ø150x150x150	150	150	150	150	150
30	SLVWRS 155 (30MM)	155x155x155MM	AL2024 T3	Ø155x155x155	155	155	155	155	155
31	SLVWRS 160 (30MM)	160x160x160MM	AL2024 T3	Ø160x160x160	160	160	160	160	160
32	SLVWRS 165 (30MM)	165x165x165MM	AL2024 T3	Ø165x165x165	165	165	165	165	165
33	SLVWRS 170 (30MM)	170x170x170MM	AL2024 T3	Ø170x170x170	170	170	170	170	170
34	SLVWRS 175 (30MM)	175x175x175MM	AL2024 T3	Ø175x175x175	175	175	175	175	175
35	SLVWRS 180 (30MM)	180x180x180MM	AL2024 T3	Ø180x180x180	180	180	180	180	180
36	SLVWRS 185 (30MM)	185x185x185MM	AL2024 T3	Ø185x185x185	185	185	185	185	185
37	SLVWRS 190 (30MM)	190x190x190MM	AL2024 T3	Ø190x190x190	190	190	190	190	190
38	SLVWRS 195 (30MM)	195x195x195MM	AL2024 T3	Ø195x195x195	195	195	195	195	195
39	SLVWRS 200 (30MM)	200x200x200MM	AL2024 T3	Ø200x200x200	200	200	200	200	200
40	SLVWRS 205 (30MM)	205x205x205MM	AL2024 T3	Ø205x205x205	205	205	205	205	205
41	SLVWRS 210 (30MM)	210x210x210MM	AL2024 T3	Ø210x210x210	210	210	210	210	210
42	SLVWRS 215 (30MM)	215x215x215MM	AL2024 T3	Ø215x215x215	215	215	215	215	215
43	SLVWRS 220 (30MM)	220x220x220MM	AL2024 T3	Ø220x220x220	220	220	220	220	220
44	SLVWRS 225 (30MM)	225x225x225MM	AL2024 T3	Ø225x225x225	225	225	225	225	225
45	SLVWRS 230 (30MM)	230x230x230MM	AL2024 T3	Ø230x230x230	230	230	230	230	230
46	SLVWRS 235 (30MM)	235x235x235MM	AL2024 T3	Ø235x235x235	235	235	235	235	235
47	SLVWRS 240 (30MM)	240x240x240MM	AL2024 T3	Ø240x240x240	240	240	240	240	240
48	SLVWRS 245 (30MM)	245x245x245MM	AL2024 T3	Ø245x245x245	245	245	245	245	245
49	SLVWRS 250 (30MM)	250x250x250MM	AL2024 T3	Ø250x250x250	250	250	250	250	250
50	SLVWRS 255 (30MM)	255x255x255MM	AL2024 T3	Ø255x255x255	255	255	255	255	255
51	SLVWRS 260 (30MM)	260x260x260MM	AL2024 T3	Ø260x260x260	260	260	260	260	260
52	SLVWRS 265 (30MM)	265x265x265MM	AL2024 T3	Ø265x265x265	265	265	265	265	265
53	SLVWRS 270 (30MM)	270x270x270MM	AL2024 T3	Ø270x270x270	270	270	270	270	270
54	SLVWRS 275 (30MM)	275x275x275MM	AL2024 T3	Ø275x275x275	275	275	275	275	275
55	SLVWRS 280 (30MM)	280x280x280MM	AL2024 T3	Ø280x280x280	280	280	280	280	280
56	SLVWRS 285 (30MM)	285x285x285MM	AL2024 T3	Ø285x285x285	285	285	285	285	285
57	SLVWRS 290 (30MM)	290x290x290MM	AL2024 T3	Ø290x290x290	290	290	290	290	290
58	SLVWRS 295 (30MM)	295x295x295MM	AL2024 T3	Ø295x295x295	295	295	295	295	295
59	SLVWRS 300 (30MM)	300x300x300MM	AL2024 T3	Ø300x300x300	300	300	300	300	300
60	SLVWRS 305 (30MM)	305x305x305MM	AL2024 T3	Ø305x305x305	305	305	305	305	305
61	SLVWRS 310 (30MM)	310x310x310MM	AL2024 T3	Ø310x310x310	310	310	310	310	310
62	SLVWRS 315 (30MM)	315x315x315MM	AL2024 T3	Ø315x315x315	315	315	315	315	315
63	SLVWRS 320 (30MM)	320x320x320MM	AL2024 T3	Ø320x320x320	320	320	320	320	320
64	SLVWRS 325 (30MM)	325x325x325MM	AL2024 T3	Ø325x325x325	325	325	325	325	325
65	SLVWRS 330 (30MM)	330x330x330MM	AL2024 T3	Ø330x330x330	330	330	330	330	330
66	SLVWRS 335 (30MM)	335x335x335MM	AL2024 T3	Ø335x335x335	335	335	335	335	335
67	SLVWRS 340 (30MM)	340x340x340MM	AL2024 T3	Ø340x340x340	340	340	340	340	340
68	SLVWRS 345 (30MM)	345x345x345MM	AL2024 T3	Ø345x345x345	345	345	345	345	345
69	SLVWRS 350 (30MM)	350x350x350MM	AL2024 T3	Ø350x350x350	350	350	350	350	350
70	SLVWRS 355 (30MM)	355x355x355MM	AL2024 T3	Ø355x355x355	355	355	355	355	355
71	SLVWRS 360 (30MM)	360x360x360MM	AL2024 T3	Ø360x360x360	360	360	360	360	360
72	SLVWRS 365 (30MM)	365x365x365MM	AL2024 T3	Ø365x365x365	365	365	365	365	365
73	SLVWRS 370 (30MM)	370x370x370MM	AL2024 T3	Ø370x370x370	370	370	370	370	370
74	SLVWRS 375 (30MM)	375x375x375MM	AL2024 T3	Ø375x375x375	375	375	375	375	375
75	SLVWRS 380 (30MM)	380x380x380MM	AL2024 T3	Ø380x380x380	380	380	380	380	380
76	SLVWRS 385 (30MM)	385x385x385MM	AL2024 T3	Ø385x385x385	385	385	385	385	385
77	SLVWRS 390 (30MM)	390x390x390MM	AL2024 T3	Ø390x390x390	390	390	390	390	390
78	SLVWRS 395 (30MM)	395x395x395MM	AL2024 T3	Ø395x395x395	395	395	395	395	395
79	SLVWRS 400 (30MM)	400x400x400MM	AL2024 T3	Ø400x400x400	400	400	400	400	400
80	SLVWRS 405 (30MM)	405x405x405MM	AL2024 T3	Ø405x405x405	405	405	405	405	405
81	SLVWRS 410 (30MM)	410x410x410MM	AL2024 T3	Ø410x410x410	410	410	410	410	410
82	SLVWRS 415 (30MM)	415x415x415MM	AL2024 T3	Ø415x415x415	415	415	415	415	415
83	SLVWRS 420 (30MM)	420x420x420MM	AL2024 T3	Ø420x420x420	420	420	420	420	420
84	SLVWRS 425 (30MM)	425x425x425MM	AL2024 T3	Ø425x425x425	425	425	425	425	425
85	SLVWRS 430 (30MM)	430x430x430MM	AL2024 T3	Ø430x430x430	430	430	430	430	430
86	SLVWRS 435 (30MM)	435x435x435MM	AL2024 T3	Ø435x435x435	435	435	435	435	435
87	SLVWRS 440 (30MM)	440x440x440MM	AL2024 T3	Ø440x440x440	440	440	440	440	440
88	SLVWRS 445 (30MM)	445x445x445MM	AL2024 T3	Ø445x445x445	445	445	445	445	445
89	SLVWRS 450 (30MM)	450x450x450MM	AL2024 T3	Ø450x450x450	450	450	450	450	450
90	SLVWRS 455 (30MM)	455x455x455MM	AL2024 T3	Ø455x455x455	455	455	455	455	455
91	SLVWRS 460 (30MM)	460x460x460MM	AL2024 T3	Ø460x460x460	460	460	460	460	460
92	SLVWRS 465 (30MM)	465x465x465MM	AL2024 T3	Ø465x465x465	465	465	465	465	465
93	SLVWRS 470 (30MM)	470x470x470MM	AL2024 T3	Ø470x470x470	470	470	470	470	470
94	SLVWRS 475 (30MM)	475x475x475MM	AL2024 T3	Ø475x475x475	475	475	475	475	475
95	SLVWRS 480 (30MM)	480x480x480MM	AL2024 T3	Ø480x480x480	480	480	480	480	480
96	SLVWRS 485 (30MM)	485x485x485MM	AL2024 T3	Ø485x485x485	485	485	485	485	485
97	SLVWRS 490 (30MM)	490x490x490MM	AL2024 T3	Ø490x490x490	490	490	490	490	490
98	SLVWRS 495 (30MM)	495x495x495MM	AL2024 T3	Ø495x495x495	495	495	495	495	495
99	SLVWRS 500 (30MM)	500x500x500MM	AL2024 T3	Ø500x500x500	500	500	500	500	500
100	SLVWRS 505 (30MM)	505x505x505MM	AL2024 T3	Ø505x505x505	505	505	505	505	505

NOTE:-
• SLVWRS IS USED WITH WRS MODULES.

NOTE:-
• ALL DIMENSIONS ARE IN MM

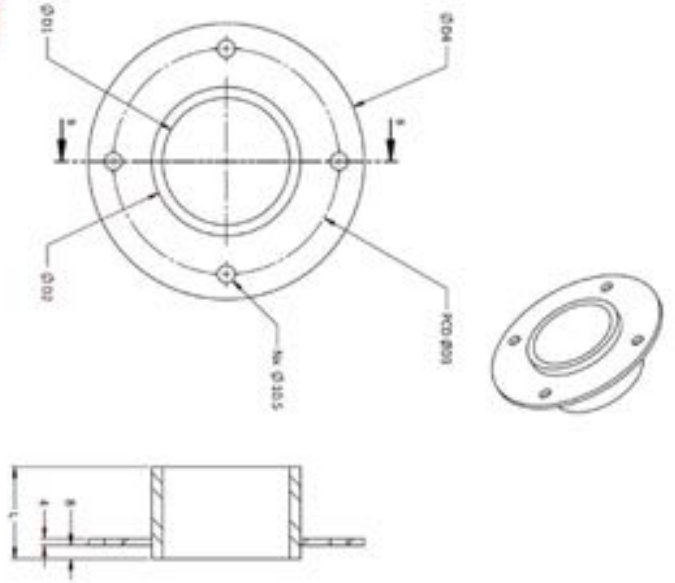

SLVFWRS SIZES CHART

SLVFWRS TYPE	PART NO.	MATERIAL	FINISH	Ø1 (mm)	Ø2 (mm)	Ø3 (mm)	Ø4 (mm)	Ø5 (mm)	Ø6 (mm)
1	SLVFWRS 10 (30MM)	10x10x10MM	AL2024 T3	10	10	10	10	10	10
2	SLVFWRS 15 (30MM)	15x15x15MM	AL2024 T3	15	15	15	15	15	15
3	SLVFWRS 20 (

WM Mini Top General Product Datasheet

WallMax®
PRODUCT CATALOGUE

WM mini Top

NOTE:-
1. ALL DIMENSIONS ARE IN MM.

SECTION B-B

ISOMETRIC VIEW

PACKING SPACE

REF. NO.	DESCRIPTION	REF. NO.	DESCRIPTION
01	EXPANDER	01	EXPANDER
02	VALVE	02	VALVE
03	CASSETT	03	CASSETT

TERMS

REF. NO.	DESCRIPTION	REF. NO.	DESCRIPTION
01	EXPANDER	01	EXPANDER
02	VALVE	02	VALVE
03	CASSETT	03	CASSETT

OPTIONAL LAYOUT OF EXPANDER BOX

WM Mini Back General Product Datasheet

WallMax®
PRODUCT CATALOGUE

WM mini Back

NOTE:-
1. ALL DIMENSIONS ARE IN MM.

SECTION B-B

ISOMETRIC VIEW

PACKING SPACE

REF. NO.	DESCRIPTION	REF. NO.	DESCRIPTION
01	EXPANDER	01	EXPANDER
02	VALVE	02	VALVE
03	CASSETT	03	CASSETT

TERMS

REF. NO.	DESCRIPTION	REF. NO.	DESCRIPTION
01	EXPANDER	01	EXPANDER
02	VALVE	02	VALVE
03	CASSETT	03	CASSETT

OPTIONAL LAYOUT OF EXPANDER BOX

Certifications

WallMax® Ingress Protection Solutions have been certified by internationally recognised tests labs, which have conducted rigorous testing to guarantee performance of the products and compliance with market standards.

Our products offer different characteristics in terms of water and dust proof, fire resistance, and water & air-gas tightness.

Ask us about our certifications, we will be happy to provide detailed information.

Certificazioni

I sistemi di sigillatura WallMax® sono stati rigorosamente testati da enti certificatori riconosciuti a livello internazionale che ne hanno attestato le qualità, le caratteristiche di resistenza e la conformità agli standard del mercato.

Le nostre soluzioni hanno diverse caratteristiche in termini di resistenza all'acqua, al fuoco, alla polvere e al gas. Contattateci per ulteriori dettagli, saremo lieti di fornirVi informazioni sulle certificazioni ottenute dai prodotti della nostra gamma.

Disclaimer

Any warranty or certification given by WallMax® in respect of any of its Products is conditioned upon the installation and storage of the Products conforming to the specifications set forth in WallMax' manual and/or installation instructions as may be amended from time to time.

The following items are not covered by WallMax® warranty:

- Any loss of profits or savings or incidental, punitive, special or consequential damages.
- Any failure that results from an accident, abuse, neglect, or failure to operate or install the product in accordance with the instructions provided in the installation instructions.
- Costs of removal, freight, delivery and reinstallation.
- WallMax® Products and systems are not warranted if used for purposes other than those they were designed to perform.
- WallMax® cannot be held liable for any errors that may have occurred during the compilation of this catalog and reserves the right to make design and dimensional modifications to the described products as part of our development and improvement programs.

Any warranty given by WallMax® shall not be transferred and is exclusively to the sole benefit of the original purchaser.

To the extent allowed by any applicable mandatory laws, WallMax® disclaims all implied or express warranties or conditions, including any implied warranties of merchantability and fitness for a particular purpose.

Copyright

The entire contents of this catalogue, including but not limited to text, images, and the selection and arrangement of information (collectively the "Materials"), are protected by copyright and other intellectual property laws. WallMax® reserves the right to change the Materials and information contained herein at any time without notice.



WALLMAX®

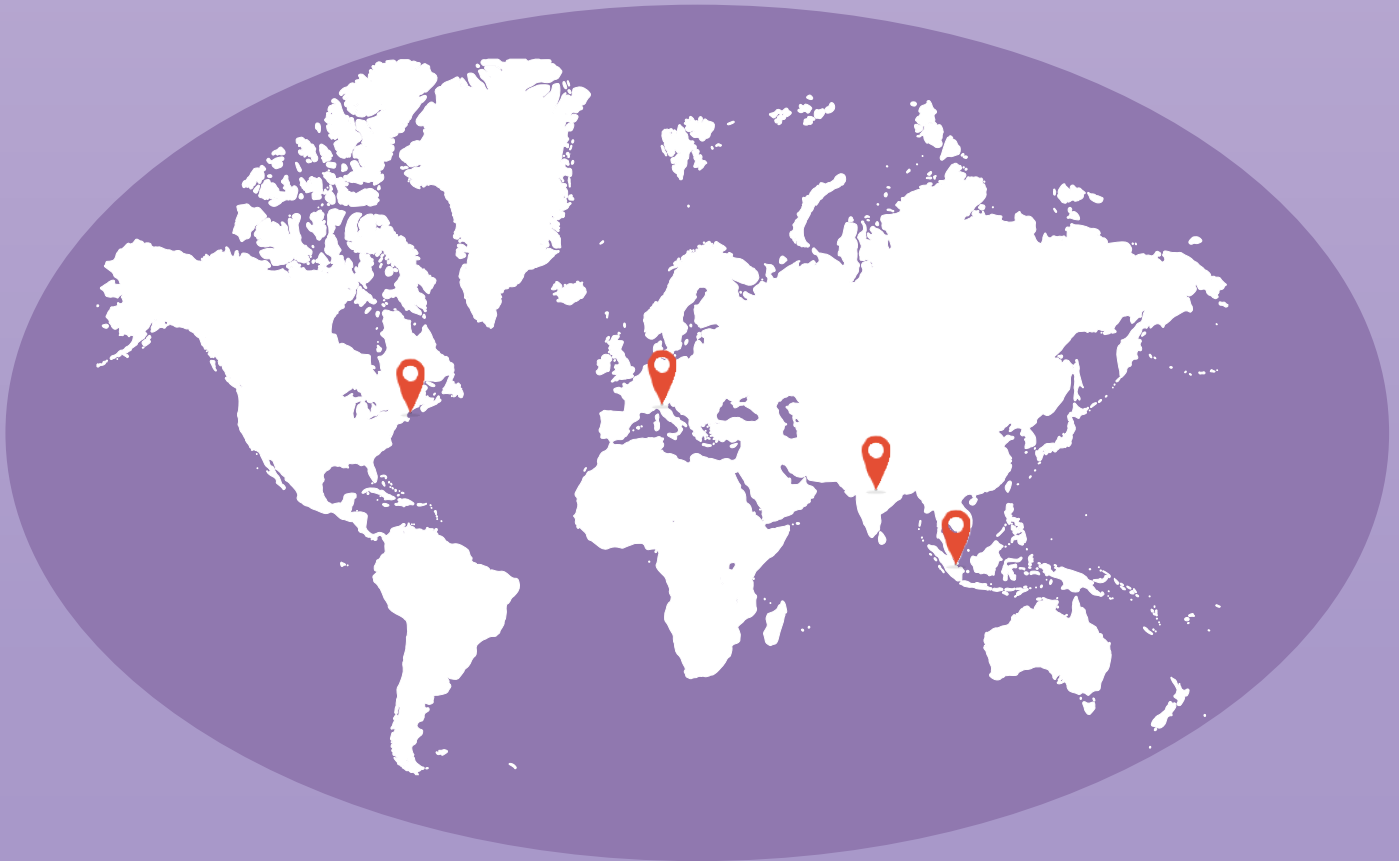

Headquarters

WallMax S.r.l.
Corso di Porta Nuova, 22
20121 Milano
Italy
Tel: +39 0236520000
info@wallmax.it

India

WallMax India Enterprises Pvt. Ltd.
12/6 Golden Peacock Complex
Main Mathura Road
121003 Faridabad, Haryana,
India
Tel: +91 129 2252381
Fax: +91 129 2250181

Singapore

WallMax Singapore Pte.
Ltd.
31 Woodlands Close
#04-19 Woodlands Horizon
Singapore
737855 Singapore
Tel: +65 6777 0182
Fax: +65 6777 0193

USA

WallMax USA Corp.
44 Wall Street - 10th Fl.
New York, NY 10005